



1921 Bellamah NW
Albuquerque, NM 87104
t. 505.243.9889
f. 505.243.8197
www.cssabq.com

email us @
esr@cssabq.com

FOR YOUR INFORMATION

CONVENTION SERVICES OF THE SOUTHWEST. INC.

2022 SWTA ANNUAL TRANSIT CONFERENCE & EXPO
Gaylord Rockies Resort & Convention Center
Aurora, Colorado
Thursday, February 23 – Friday, February 24, 2023

Dear Exhibitor:

WELCOME! CSS is pleased to be selected by show management to serve as your Official Service Contractor.

This Exhibitor Service Kit will assist you in planning for the show. In addition to important show information, we have included the necessary show service order forms. To help save you money, we have provided you with the opportunity to take advantage of advance order discounts.

When placing your order, please keep in mind:

- [On-Line Ordering](#) is available. Log-in information will be automatically emailed to the address on file with the association at the time of registration. If you do not receive the log-in, or are not the registered contact, please contact us at esr@cssabq.com or (505) 243-9889 to obtain one.
- Complete and return all order forms by the indicated discounted deadline date to avoid higher costs. Each form should be returned to the appropriate company and address listed on that form.
- Review our payment policy carefully. **CSS** requires payment in full at the time you place your order, along with a completed Credit Card Authorization form.
- Please include the prevailing sales tax in your order, **currently 8.5% in Aurora, Colorado**. Sales tax is applicable to rentals and some labor services. Some labor and material handling services may be exempt in the state of Colorado. *(If you have a state or federal exemption, please include with forms at the time of ordering.)*

We will help you coordinate all your trade show needs including the shipment of all your trade show materials. For your inbound and outbound freight shipments, we offer the service of our preferred carrier **CSS Logistics (505) 243-9889**.

We look forward to serving you from start to finish. We are here to make sure your experience is a complete success. If you need assistance or additional information, please contact our Exhibitor Service Department:

Email: esr@cssabq.com
1921 Bellamah Ave. NW
Albuquerque, NM 87104
Phone: (505) 243-9889
Fax: (505) 243-8197

Or visit us on the World Wide Web at <http://www.cssabq.com>.



1921 Bellamah NW
 Albuquerque, NM 87104
 t. 505.243.9889
 f. 505.243.8197
 www.cssabq.com

email us @
 esr@cssabq.com

SHOW INFORMATION QUICK REFERENCE

CONVENTION SERVICES OF THE SOUTHWEST, INC.

SHOW NAME:	2023 SWTA Annual Transit Conference & Expo	
VEHICLE MOVE-IN:	Wednesday, February 22, 2023	3:00PM
EXHIBITOR MOVE-IN:	Wednesday, February 22, 2023	5:00PM – 8:00PM
	Thursday, February 23, 2023	7:00AM – 11:00AM
SHOW DATE(S):	Thursday, February 23, 2023	12:00PM – 4:00PM
	Thursday, February 23, 2023	5:00PM – 7:00PM <i>(Reception)</i>
	Friday, February 24, 2023	9:00AM – 11:00AM
VEHICLE MOVE-OUT:	Friday, February 24, 2023	11:00AM – 2:00PM
EXHIBITOR MOVE-OUT:	Friday, February 24, 2023	11:00PM – 2:00PM

Outside freight carriers must be checked in by: **Friday, February 24, 2023 @ 1:00PM**
 All materials must be packed with bill(s) of lading turned in to **CSS** by: **Friday, February 24, 2023 @ 2:00PM**

SHOW LOCATION: Gaylord Rockies Resort & Convention Center
 Hall 1
 6700 N Gay lord Rockies Blvd
 Aurora, CO 80019

STANDARD BOOTH PACKAGE: **10' x 10'**
 (Included with booth purchase) 8' Blue/Beige Draped Back Wall
 3' Blue Draped Side Rail
 (1) 6' Red Draped Table
 (2) Molded Plastic Chairs
 (1) Waste Basket w/ Liner
 (1) 7" x 44" ID Sign

Aisle Carpet color is **Blue Jay**.

The exhibit hall **IS NOT** carpeted.

IMPORTANT DEADLINES:

First date freight can arrive at the advance warehouse:	Monday, January 23, 2023
Submission deadline for exhibitor appointed contractor (EAC) notification:	Monday, January 23, 2023
Last date to receive certificate of insurance for EAC:	Monday, January 23, 2023
Advance Orders and Payment Deadline:	Thursday, February 02, 2023
Last date freight can arrive at the advance warehouse:	Monday, February 20, 2023
First date for direct shipments to facility:	Wednesday, February 22, 2023

SHIPPING INFORMATION:

ADVANCE FREIGHT RECEIVING

Monday – Friday 8:00AM – 4:00PM

Monday, January 23 – Monday, February 20, 2023

ADVANCE SHIPPING ADDRESS

Ship To: Exhibitor Name and Booth #
 SWTA 2023
 c/o **CSS**
 YRC Denver - 890
 14700 Smith Road
 Aurora, CO 80011

FIRST DAY FOR DIRECT FREIGHT

Wednesday, February 22, 2023 --- 8:00AM – 5:00PM

DIRECT SHIPPING ADDRESS

Ship To: Exhibitor Name and Booth #
 c/o **CSS**
 SWTA 2023
 Gaylord Convention Ctr Dock – Hall 1
 6700 North Gaylord Rockies Blvd
 Aurora, CO 80019



1921 Bellamah NW
 Albuquerque, NM 87104
 t. 505.243.9889
 f. 505.243.8197
 www.cssabq.com

email us @
 esr@cssabq.com

CREDIT CARD AUTHORIZATION ORDER SUMMARY FORM TERMS AND CONDITIONS ACCEPTANCE

CONVENTION SERVICES OF THE SOUTHWEST, INC.

Event Name: SWTA 2023	Advance Payment Deadline: Thursday, February 2, 2023	Booth # (s):
Company Name:	Telephone #:	
Billing Address:	Fax #:	
City/State/Zip:	Email Address:	
Authorized by:		

CREDIT CARD CHARGE AUTHORIZATION

Please complete the information requested below and return this form with your order(s). Any show site balances or charges for outbound labor, freight or miscellaneous items not paid before show closing will be charged to your credit card account. Your signature below acknowledges understanding and acceptance of the terms detailed in the **CSS** Payment Policy, the **CSS** Material Handling Information and Limits of Liability, and the **CSS** Conditions and Regulations for electrical usage provided with your Service Kit. Acceptance of **CSS**' payment policy, material handling terms and conditions, and limits of liability will be construed when any of the following conditions are met: This Credit Card Authorization is signed, the Material Handling Agreement (MHA) is signed; Exhibitor's materials are delivered to **CSS**'s warehouse or to an event site for which **CSS** is the Official Show Contractor; or an order for labor and/or rental equipment is placed by Exhibitor with **CSS**. **The Estimated Total below may not necessarily reflect the final total charged to your credit card at close of show.** (There will be a \$75.00 administrative fee if a credit card dispute is filed and **CSS** is awarded charges.)

Account #:

Expiration Date: Billing Zip Code:

Card Verification # (3 or 4 Digit Code on Card):

Cardholder Signature
Cardholder Name (please print)

CSS ORDER FORMS	AMOUNT DUE
Furnishings	
Upgrade Furnishings	
Carpet / Prestige Carpet	
Rental Display	
Labor	
Vehicle Spotting	
Material Handling	
Cleaning	
Floral	
Signs/Graphics	
<i>Information included but ordered from a different location</i>	
Facility Services (Electrical, AV, Internet, Catering, Rigging)	XXXXXXXX
Estimated Total (includes State Tax where applicable)	

Using the order forms, remember to include and transfer the sales tax into the estimated grand total above.
This form is intended as a tool to assist you and is not a replacement for any other form.



1921 Bellamah NW
Albuquerque, NM 87104
t. 505.243.9889
f. 505.243.8197
www.cssabq.com

email us @
esr@cssabq.com

PAYMENT POLICY

CONVENTION SERVICES OF THE SOUTHWEST, INC.

ADVANCE PRICING

To obtain the advance pricing, full payment must be included with your order. Orders received after the advance payment deadline date or made at the Exhibitor Service Center during the show, will be billed at the "Standard Price" as listed on the enclosed forms. **Telephone orders will not be accepted.**

PAYMENT OPTIONS

We offer two convenient ways for you to order and pay for your show services provided by **CSS**.

1. Service Kit (pdf download)
 - a. Advance payment by **Company Check, Wire Transfer, or e-check**: All checks for show services provided by **CSS** should be made payable to **Convention Services of the Southwest, Inc. (CSS)** and must be in U.S. Dollars drawn on a U.S. bank. International exhibitors must prepay all balances no later than the advanced payment deadline in U.S. Dollars drawn on U.S. banks. A **Credit Card Authorization** form is also required to cover any variances with regards to drayage (material handling) and labor orders as well as any additional charges incurred at show site.
 - i. Please note that for Wire Transfer/ACH payments, **CSS** does not pay bank fees from the sending or receiving bank. Please add \$25.00 to amounts transferred to be considered paid in full.
 - ii. **CSS** will add a fee of \$35.00 to any order where the check payment is returned as insufficient funds.
 - b. **Credit Card**: For your convenience we accept Visa, MasterCard, and American Express. You must complete the **Credit Card Authorization** form. For discount rates to apply, **CSS** must receive this form by **Thursday, February 2, 2023**. *(There will be a \$75.00 administrative fee if a credit card dispute is filed and CSS is awarded charges.)*
2. **On-Line Ordering**
 - a. Log-in information with a temporary password will be automatically emailed to the email address on file with the association at the time of registration. To place your order, log-in and follow the instructions. A credit card on file is required to complete your order. An email will be sent confirming your order is complete. The charges on your confirmation will not be considered final until the show closes *(drayage fees are added once freight is received and floor orders may be added)*.

PAYMENT TERMS

To process your order for services and materials listed in this Exhibitor Service Kit, we must have your completed and signed Credit Card Authorization form or full payment in advance or you must place your order on-line. Invoices for outstanding balances will be emailed to the email address on file and must be paid before the end of the event. If you have any concerns about your charges, please stop by the Exhibitor Service Center at the show. **Charges may not be disputed after the show.**

Items ordered and delivered but subsequently canceled will be charged 50% of the order price to cover labor involved.

Please notify your company representative who will be at the show site of our payment policy. Your cooperation is appreciated. No credits will be issued after close of show.

If a display house represents the exhibiting company, the exhibiting company is ultimately responsible for payment of all costs incurred on its behalf. (See **Third Party Payment Form**). **Third Parties must contact CSS for an on-line log in.**



1921 Bellamah NW
 Albuquerque, NM 87104
 t. 505.243.9889
 f. 505.243.8197
 www.cssabq.com

email us @
 esr@cssabq.com

THIRD PARTY PAYMENT FORM

CONVENTION SERVICES OF THE SOUTHWEST. INC.

CSS will present show site invoices to third parties for payment of services rendered to exhibitors, provided the following conditions are met:

- The payment record of the third party is acceptable to **CSS**.
- This completed form is to be signed by **BOTH PARTIES** and returned to **CSS** by **Thursday, February 2, 2023**.
- This form is to be accompanied by a completed **Credit Card Authorization** form from **EACH PARTY**.
- If there is any doubt which party is to be invoiced for a service, **the exhibiting firm accepts responsibility for payment upon presentation of invoice at show site**.
- The **exhibiting firm** is ultimately responsible for payment of all charges by show close.

Please indicate below which items/services are to be invoiced to the third party:

Furniture/Carpet
 Booth Cleaning
 Material Handling
 Booth Labor

Other:

WE UNDERSTAND AND AGREE THAT WE, THE EXHIBITING COMPANY, ARE ULTIMATELY RESPONSIBLE FOR PAYMENT OF CHARGES INCURRED. IN THE EVENT THE NAMED THIRD PARTY DOES NOT MAKE PAYMENT UPON PRESENTATION OF INVOICE AT SHOW SITE, SUCH CHARGES WILL BE PRESENTED TO THE EXHIBITING COMPANY FOR PAYMENT BEFORE THE CLOSE OF THE SHOW.

Event Name: SWTA 2023	Booth #:
Exhibiting Company:	Display House 3rd Party:
Address:	Address:
City/State/Zip:	City/State/Zip:
Telephone #:	Telephone #:
Fax #:	Fax #:
Email address:	Email address:
Authorized Signature:	Authorized Signature:
Print Name & Title:	Print Name & Title:



1921 Bellamah NW
 Albuquerque, NM 87104
 t. 505.243.9889
 f. 505.243.8197
 www.cssabq.com

email us @
 esr@cssabq.com

FURNISHINGS ORDER FORM

CONVENTION SERVICES OF THE SOUTHWEST, INC.

Event Name: SWTA 2023	Advance Payment Deadline: Thursday, February 2, 2023	Booth # (s):
Company Name:	Telephone #:	
Billing Address:	Fax #:	
City/State/Zip:	Email Address:	
Authorized by:		

DRAPED DISPLAY TABLES - 30" HIGH (choose skirt color below)

Quantity	Description	Advance Price	Standard Price
	4'L X 30"H Draped Table	164	196
	6'L X 30"H Draped Table	184	220
	8'L X 30"H Draped Table	214	257

DRAPED DISPLAY COUNTERS - 40" HIGH (choose skirt color below)

	4'L X 40"H Draped Counter	187	224
	6'L X 40"H Draped Counter	225	270
	8'L X 40"H Draped Counter	246	295
	30"D X 40"H Spandex Round Highboy	211	253

UNDRAPED DISPLAY TABLES - 30" HIGH

	4'L X 30"H Undraped Table	94	113
	6'L X 30"H Undraped Table	108	129
	8'L X 30"H Undraped Table	137	164
	30"H Conference Table (circle choice) 36"D Black 36" D White 40"D Grey	295	354

UNDRAPED DISPLAY COUNTERS - 40" HIGH

	4'L X 40"H Undraped Counter	108	129
	6'L X 40"H Undraped Counter	125	150
	8'L X 40"H Undraped Counter	143	172
	40"H Conference Counter (circle choice) 36"D Black 36" D White 40"D Grey	316	378

TABLE SKIRTING (choose skirt color below)

	4th Side Table Drape for Table 30"H	92	111
	4th Side Table Drape for Counter 40"H	108	130
	Individual Table Skirt for Table 30"H	111	133
	Individual Table Skirt for Counter 40"H	128	154

SPECIAL DRAPERY (6' minimum) (choose drape color below)

	3' High Drapery/linear ft.	14	18
	8' High Drapery/linear ft.	24	28
	3' Upright w/ 1/2 Base	26	30
	8' Upright w/ Full Base	27	32
	Crossbar	27	32

STANDARD FURNITURE AND ACCESSORIES

	Grey Molded Plastic Chair	72	84
	Padded Side Chair	96	113
	Padded Arm Chair	105	122
	Upholstered Bar Stool with Back	118	138
	Bag Rack (circle choice) "T" waterfall	94	106
	Literature Rack (circle choice) flat accordion	223	249
	Aluminum Easel	44	49
	iPad Stand	253	284
	Wastebasket with Liner	30	34
	Fishbowl	42	47
	4' x 8' Board* Peg Board or Poster Board (circle choices) Horizontal or Vertical	204	245
	36" x 48" Double Sided Magnetic Whiteboard	204	245
	4'L X 7"H Table Riser (draped in vinyl)	79	95
	6'L X 7"H Table Riser (draped in vinyl)	103	110
	Glass Show Case (48"W x 18"D x 38"H w/lock and light)	443	Contact for Quote

*Maximum load on boards is 50 lbs. Poster Boards are black & Velcro/push pin "friendly".

SKIRT AND DRAPE COLOR CHOICES (please circle choice)

Blue Gold Teal Beige Hunter Green
 Black White Peach Burgundy Terra-Cotta
 Red Silver Plum

SPANDEX COLOR CHOICES (please circle choice)

Red Black Blue
 White Teal Silver

PLEASE READ PAYMENT POLICY

SUBTOTAL	\$
Tax (8.5%)	\$
TOTAL	\$



1921 Bellamah NW
 Albuquerque, NM 87104
 t. 505.243.9889
 f. 505.243.8197
 www.cssabq.com

email us @
 esr@cssabq.com

STANDARD FURNISHINGS

CONVENTION SERVICES OF THE SOUTHWEST, INC.



DRAPED TABLE
 2' W X (4', 6', OR 8' L) X 30" H



DRAPED COUNTER
 2' W X (4', 6', OR 8' L) X 40" H



UNDRAPED TABLE/COUNTER
 2' W X (4', 6', OR 8' L) X 30" H OR 40" H



SPANDEX HIGHBOY
 30" D X 40" H



ROUND CONFERENCE TABLE/COUNTER
 36" D (BLACK/WHITE) or
 40" D (GREY) x 30" or 40" H

DRAPE COLORS

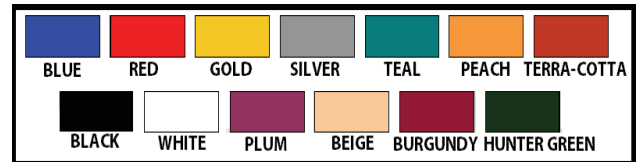

SPANDEX COLORS

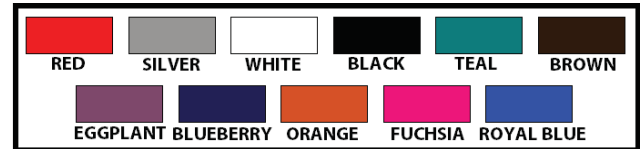

MOLDED PLASTIC CHAIR



PADDED SIDE CHAIR



PADDED ARM CHAIR



UPHOLSTERED BAR STOOL



1921 Bellamah NW
Albuquerque, NM 87104
t. 505.243.9889
f. 505.243.8197
www.cssabq.com

email us @
esr@cssabq.com

STANDARD FURNISHINGS

CONVENTION SERVICES OF THE SOUTHWEST, INC.



T STYLE BAG RACK
50" H X 15" W X 12" L



WATERFALL BAG RACK
50" H X 15" W X 12" L



ALUMINUM EASEL
64" H X 32" W X 32" L



FLAT LITERATURE STAND WITH 6
POCKETS
55" H X 14" W X 9" L



ACCORDION LITERATURE
STAND
5' HIGH



IPAD STAND WITH ADJUSTABLE
POLE (28" - 44")
BASE 18" X 14"

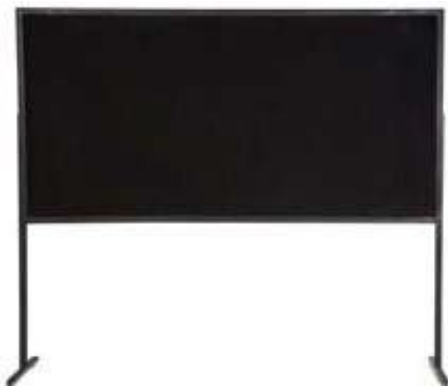

POSTER BOARD
(HORIZONTAL)
4' X 8'



WHITEBOARD (VERTICAL)
36"W X 48"H + FRAME



GLASS SHOW CASE
38" H X 48" W X 18" D



1921 Bellamah NW
Albuquerque, NM 87104
t. 505.243.9889
f. 505.243.8197
www.cssabq.com

email us @
esr@cssabq.com

UPGRADE FURNISHINGS ORDER FORM

CONVENTION SERVICES OF THE SOUTHWEST, INC.

Event Name: SWTA 2023	Advance Payment Deadline: Thursday, February 2, 2023	Booth # (s):
Company Name:	Telephone #:	
Billing Address:	Fax #:	
City/State/Zip:	Email Address:	
Authorized by:		

Note: Due to limited quantities on many items, a comparable product may be substituted.
Please contact **CSS** for quantity availabilities.

UPGRADE CHAIRS

Quantity	Description	Dimensions	Color (please circle)	Price
	Jetson Chair	15" x 15" w/ adjustable seat	White Black	195
	Leather Office Chair w/ Mesh Back	34.7"H x 22.75"W x 24"D	Black Only	162
	Mesh Steno Chair w/ Wheels	38.5-42.2"H x 27.1"W x 26.7"D	Black Only	195
	Modern Chair	33.5"H x 18.8"W x 18.8"D	White Only	162
	Soda Fountain Barstool	30"H x 17"W x 17"D	Red Black	162
	Swivel Barstools w/ Curved Back	32.5"H x 22.5"W x 18"D	White Black	227

UPGRADE TABLES

	24" Bistro Table	23.75" - 42"H x 24"W x 24"D	White Black	259
	31" Glass Table	29"H x 31.5"W x 31.5"D		290
	Glass End Table	15"H x 23"W x 23"D	Chrome Black	195
	Glass Coffee Table	15.8"H x 39.4"W x 19.7"D	Chrome Black	227
	Rectangular Conference Table	30"H x 36"W x 60"D		1034
	Triangle Glass Top Table	35"H x 35"W x 35"D		290

UPGRADE SEATING

	Barrel Chair	29"H x 28"W x 29"D	Black Only	355
	Leather Loveseat	34"H x 58"W x 36"D	Black Only	387
	Leather Sofa	34"H x 80"W x 36"D	Black Only	453
	White Executive Side Chair	35.25"H x 26.5"W x 23"D	White Only	306
	Chrome Leather Accent Chairs	30.5"H x 30.5"W x 27.5"D	White Black	453
	Chrome Leather Chair	32"H x 36"W x 33"D	White Only	585
	Chrome Leather Sofa	32"H x 81"W x 33"D	White Only	936
	Futon Lounger	32"H x 71"W x 34"D	Vanilla Only	549

****REFUNDS ON UPGRADE FURNISHINGS ARE NOT AVAILABLE AFTER THE ADVANCE ORDER DEADLINE DATE ABOVE****

Please contact **CSS** for custom/specialty items not listed on this order form.

PLEASE READ PAYMENT POLICY

SUBTOTAL	\$
Tax (8.5%)	\$
TOTAL	\$



1921 Bellamah NW
 Albuquerque, NM 87104
 t. 505.243.9889
 f. 505.243.8197
 www.cssabq.com

email us @
 esr@cssabq.com

UPGRADE FURNISHINGS

CONVENTION SERVICES OF THE SOUTHWEST, INC.



LEATHER OFFICE CHAIR
 WITH MESH BACK
 34.75" H x 22.75" W x 24" D



WHITE
 MODERN CHAIR
 33.5" H x 18.8" W x 18.8" D



MESH STENO CHAIR
 w/ WHEELS
 38.5-42.2" H x 27.1" W x 26.7" D



SODA FOUNTAIN
 BARSTOOL
 30" H x 17" W x 17" D
 (Available w/ black
 or red seat)



SWIVEL BARSTOOLS
 WITH
 CURVED BACK
 32.5" H x 22.5" W x 18" D
 (Available in
 black and white)



(Available
 in black
 or white)

24" BISTRO TABLE shown with JETSON CHAIRS 15"x15" (adjustable seat) – rented separately
 White – 23.75" D x 26.25" – 35.75" H (adjustable) – Black – 24" D x 42" H



1921 Bellamah NW
Albuquerque, NM 87104
t. 505.243.9889
f. 505.243.8197
www.cssabq.com

email us @
esr@cssabq.com

UPGRADE FURNISHINGS

CONVENTION SERVICES OF THE SOUTHWEST, INC.



RECTANGULAR CONFERENCE TABLE
30" H x 36" W x 60" D



TRIANGLE GLASS TOP TABLE
35" H x 35" W x 35" D



31" ROUND GLASS TOP TABLE
29" H x 31.5" D



GLASS END TABLE
(Available in chrome or black)
15" H x 23" W x 23" D



GLASS COFFEE TABLE (Available in chrome or black)
15.8" H x 39.4" W x 19.7" D



BLACK LEATHER SOFA
32" H X 80" W 33" D



BLACK LEATHER LOVE SEAT
32" H X 59" W X 33" D



BLACK LEATHER BARREL CHAIR
29" H X 28" W X 29"



WHITE EXECUTIVE SIDE CHAIR
35" H X 26" W X 23"



WHITE AND CHROME SOFA
32" H X 81" W 33" D



WHITE AND CHROME CHAIR
32" H X 80" W 33" D



CHROME LEATHER ACCENT CHAIR
30.5" H X 30.5" W
27.5" D



VANILLA FUTON LOUNGER
32" H X 71" W 34" D



1921 Bellamah NW
Albuquerque, NM 87104
t. 505.243.9889
f. 505.243.8197
www.cssabq.com

email us @
esr@cssabq.com

CARPET ORDER FORM

CONVENTION SERVICES OF THE SOUTHWEST, INC.

Event Name: SWTA 2023	Advance Payment Deadline: Thursday, February 2, 2023	Booth # (s):
Company Name:	Telephone #:	
Billing Address:	Fax #:	
City/State/Zip:	Email Address:	
Authorized by:		

STANDARD CARPET

Quantity	Description	Advance Price	Standard Price
	10' x 10' carpet	211	254
	10' x 20' carpet	368	446
	10' x 30' carpet	553	665
	10' x 40' carpet	739	887
	SPECIAL CUT STANDARD CARPET (Carpet rolls are 10' wide, so special cut would be required for sizes smaller than 10' wide or a length other than in a 10' increment.)	\$4.07 per sq. ft.	\$4.88 per sq. ft.
	Visqueen	\$1.36 per sq. ft.	\$1.64 per sq. ft.
	Carpet Padding (100 sq. ft. min)	\$2.01 per sq. ft.	\$2.42 per sq. ft.

STANDARD CARPET COLOR *(please circle color choice)*

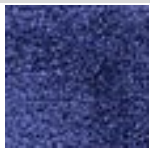

Blue



Red



Grey



Teal



Hunter Green

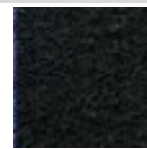

Black

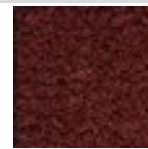

Burgundy



Plum

PAYMENT IN FULL MUST ACCOMPANY YOUR ORDER.

For your convenience, MasterCard, American Express, and Visa credit cards will be accepted.

NO TELEPHONE ORDERS WILL BE ACCEPTED.

**All utility lines must be installed before carpet installation. Utilities should be ordered in advance. **

PLEASE READ PAYMENT POLICY

SUBTOTAL	\$
Tax (8.5%)	\$
TOTAL	\$



1921 Bellamah NW
 Albuquerque, NM 87104
 t. 505.243.9889
 f. 505.243.8197
 www.cssabq.com

email us @
 esr@cssabq.com

PRESTIGE CARPET ORDER FORM

CONVENTION SERVICES OF THE SOUTHWEST, INC.

Event Name: SWTA 2023	Advance Payment Deadline: Thursday, February 2, 2023	Booth # (s):
Company Name:	Telephone #:	
Billing Address:	Fax #:	
City/State/Zip:	Email Address:	
Authorized by:		

****** ORDERS PLACED AFTER THE ABOVE DEADLINE DATE, PLEASE CALL FOR AVAILABILITY AND LATE FEES ******

SPECIAL CUT PRESTIGE CARPET

Enhance your exhibit with 30 oz. plush, heavy-cut polyester pile carpet

Carpet Size _____ x _____ = _____ square feet x \$5.35 = \$ _____ TOTAL

PRESTIGE CARPET COLOR (please circle color choice)

Pink	Magenta	Cherry Red	Red Fire	Cherry Blossom	Hay Loft	Navel
Orange	Butter Cream	Sunshine	Lime Green	Wintergreen	Pine	Forest
Pacific	Orion Blue	Lite Blue	Nautical	Caribbean	Process Blue	Bright Blue
Atlantic	Reflex Blue	Blueberry	Intense Blue	Deep Blue	Navy	Purple
Cream	Vanilla	Snowflake	White	Aluminum	Flannel	Fog
Tanium	Silver Mist	Grey Blue	Medium Grey	Cool Grey	Steel	Charcoal
Grey	English Grey	Smokey	Smoke	Black		

Visqueen is available at **\$1.36** (advanced price) or **\$1.64** (standard price) per square foot installed

_____ x _____ = _____ square feet x \$1.36 or \$1.64 = \$ _____ TOTAL

Carpet Padding is available at **\$2.01** (advanced) or **\$2.42** (standard) per square foot installed (100 sq. ft. min charge)

_____ x _____ = _____ square feet x \$2.01 or \$2.42 = \$ _____ TOTAL

****NO REFUNDS ON SPECIAL ORDER CARPET – ALL SALES ARE FINAL****

Carpet Samples are available upon request – please fill out the mailing information below.

Mail Photo to:	_____
Attention:	_____
Company:	_____
Address:	_____
City:	_____ State: _____ Zip Code: _____
Phone Number:	_____

PAYMENT IN FULL MUST ACCOMPANY YOUR ORDER.

For your convenience, MasterCard, American Express, and Visa credit cards will be accepted.

NO TELEPHONE ORDERS WILL BE ACCEPTED.

****All utility lines must be installed before carpet installation. Utilities should be ordered in advance. ****

PLEASE READ PAYMENT POLICY

SUBTOTAL	\$
Tax (8.5%)	\$
TOTAL	\$



1921 Bellamah NW
Albuquerque, NM 87104
t. 505.243.9889
f. 505.243.8197
www.cssabq.com

email us @
esr@cssabq.com

PRESTIGE CARPET COLORS

CONVENTION SERVICES OF THE SOUTHWEST, INC.

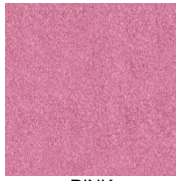

PINK



MAGENTA



CHERRY RED



RED FIRE



CHERRY BLOSSOM



HAY LOFT



NAVEL



ORANGE

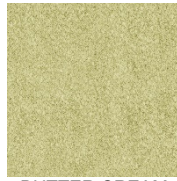

BUTTER CREAM

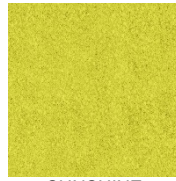

SUNSHINE



LIME GREEN

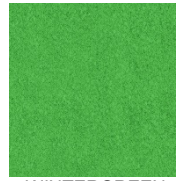

WINTERGREEN

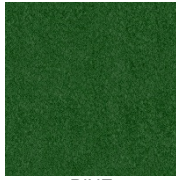

PINE



FOREST

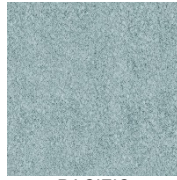

PACIFIC

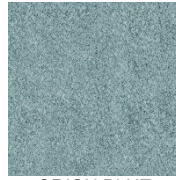

ORION BLUE

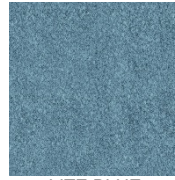

LITE BLUE

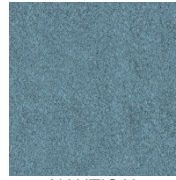

NAUTICAL

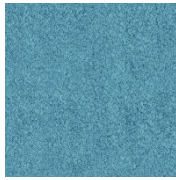

CARIBBEAN

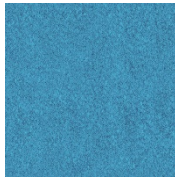

PROCESS BLUE

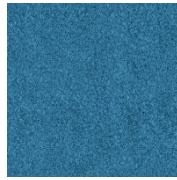

BRIGHT BLUE

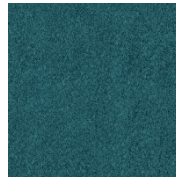

ATLANTIC

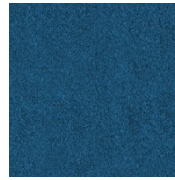

REFLEX BLUE

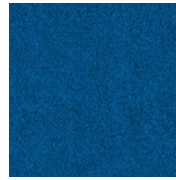

BLUEBERRY

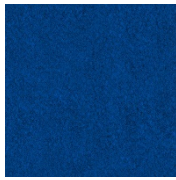

INTENSE BLUE



DEEP BLUE



NAVY



PURPLE



CREAM



VANILLA

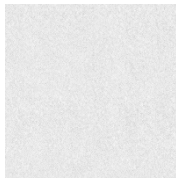

SNOWFLAKE

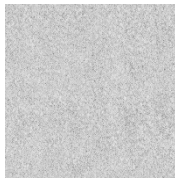

WHITE

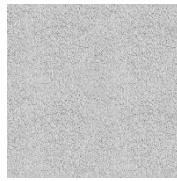

ALUMINUM



FLANNEL

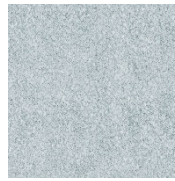

FOG

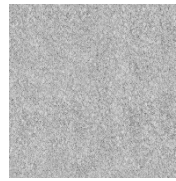

TITANIUM

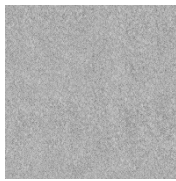

SILVER MIST



GREY BLUE

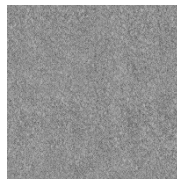

MEDIUM GREY

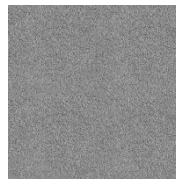

COOL GREY

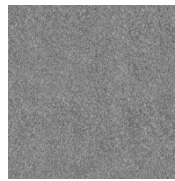

STEEL

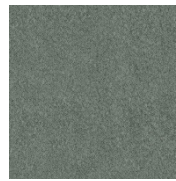

CHARCOAL

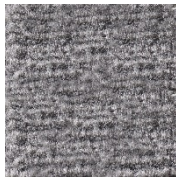

GREY

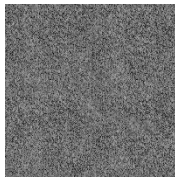

ENGLISH GREY

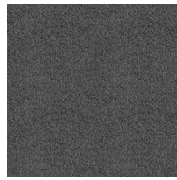

SMOKEY

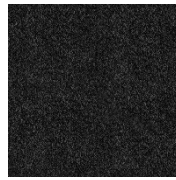

SMOKE



BLACK



1921 Bellamah NW
Albuquerque, NM 87104
t. 505.243.9889
f. 505.243.8197
www.cssabq.com

email us @
esr@cssabq.com

RENTAL DISPLAY ORDER FORM

CONVENTION SERVICES OF THE SOUTHWEST, INC.

Event Name: SWTA 2023	Advance Payment Deadline: Thursday, February 2, 2023	Booth # (s):
Company Name:	Telephone #:	
Billing Address:	Fax #:	
City/State/Zip:	Email Address:	
Authorized by:		

INCREASE YOUR PRESENCE WITH A RENTAL DISPLAY

Charges for Rental Unit include delivery to your space, installation of unit only and removal at close of show. **Unit #3007 includes one 8' draped table.** Units #3001-3006 and #3010-3025 include **Standard Carpet, and Daily Cleaning.** Electrical outlets are not included with rental of any Display Unit. All units are 8' high with 1-meter panels unless otherwise indicated.

RENTAL DISPLAY UNITS

Quantity	Description	Advance Price	Standard Price
	Basic #3000	1180	1416
	10'x10' #3010	1517	1820
	10'x10' #3001 (3 spotlights, 1 shelf)	2865	3438
	10'x10' #3002 (3 spotlights, 1 shelf, 1-1 meter counter)	3203	3842
	10'x10' #3002A (3 spotlights, 1 shelf, 1 - 1/4 round counter)	3424	4109
	10'x10' #3011 (2 spotlights, 1 - 1 meter curved counter)	3424	4109
	10'x10' #3012 (2 spotlights, 2 - 1/2 meter pedestals)	3593	4311
	10'x10' #3013 (3 spotlights, curved end back counter)	3822	4587
	10'x10' #3014 (1 spotlight, 1 - 1/4 round counter)	4045	4854
	10'x20' #3003 (6 spotlights)	4214	5056
	10'x20' #3004 (6 spotlights, 1-2 meter counter)	4496	5396
	10'x20' #3020 (5 spotlights)	4833	5799
	10'x20' #3005 (6 spotlights, 1-1 meter closet)	5056	6067
	10'x20' #3021 (6 spotlights, 1 - 2 meter radius counter)	5056	6067
	10'x20' #3022 (6 spotlights, curved header, 1 - 2 meter counter)	5170	6205
	10'x20' #3023 (6 spotlights, 1 - 2 meter counter w/ curved ends)	5170	6205
	10'x20' #3024 (6 spotlights, 4 curved shelves, 1 - 1/2 round counter)	5278	6333
	10'x20' #3025 (7 spotlights, 3 - 1.5 meter curved counters)	5446	6536
	10'x10' Office #3006	3195	3834
	Table Top Display #3007	627	752
	Custom Display Units	Contact for Quote	

Header Copy Options (please select choice):

- Custom Graphics** with logo can be provided at no additional cost. (Please contact for further instructions.)
 Standard Header: Black Block Lettering (indicate header text in box below)

Panel Type (please circle choice): Grey Velcro Black Velcro Blue Velcro White Hard Wall

Custom Graphics panels are available at an additional cost (see Sign/Graphics Order form)

Select Table Drape Color (Unit #3007 only, circle color choice):

Blue Red Gold Silver Black White Beige Plum Teal Peach Terra-Cotta Burgundy Hunter Green

Carpet Color (Units #3001- #3006 and #3010 - #3025 only, circle color choice):

Blue Red Teal Grey Plum Black Hunter Green Burgundy

ACCESSORIES

	White Pedestal (36"H x 20 1/2"W x 20 1/2"D)	284	340
	1 Meter Counter, white cabinet (36"H x 20 1/2"D w/sliding door)	506	607
	1/4 Round Counter, white (36"H w/ curved back, no door)	560	671
	1 Meter Curved Counter w/ sliding door, white (36"H w/ sliding door)	560	671
	1.5 Meter Curved Counter, white (36"H w/ sliding door)	621	745
	2 Meter Counter, white cabinet (36"H x 20 1/2"D w/sliding door)	674	809
	1/2 Round Counter (36"H w/ curved back, no door)	728	873
	2 Meter Radius Counter, white (36"H w/ curved back, no door)	728	873
	Vertical Glass Display	499	598
	Display Spotlights	64	78
	Straight Shelves with brackets	64	78
	Angle Shelves with brackets	64	78
	Side Rails, 80"L x 36"H to match display	270	323
	Clear Literature Holders, 1 pocket 8 1/2" x 11"	22	28

PLEASE READ PAYMENT POLICY

SUBTOTAL	\$
Tax (8.5%)	\$
TOTAL	\$



1921 Bellamah NW
Albuquerque, NM 87104
t. 505.243.9889
f. 505.243.8197
www.cssabq.com

email us @
esr@cssabq.com

RENTAL DISPLAY UNITS

10X10

CONVENTION SERVICES OF THE SOUTHWEST, INC.

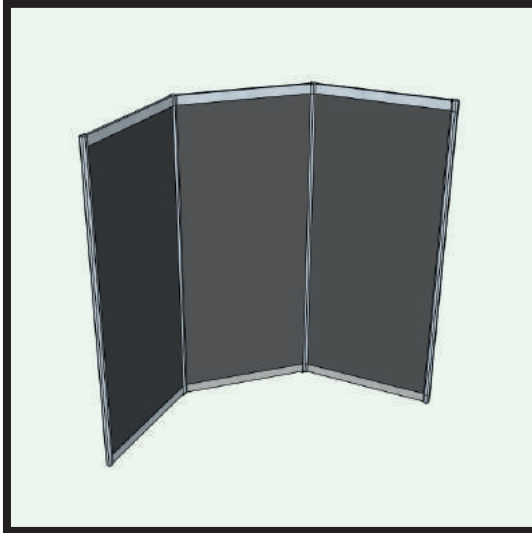

BASIC #3000

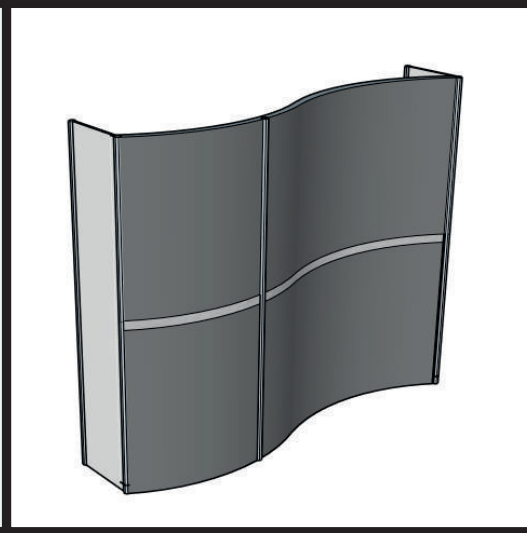

10'x10' #3010

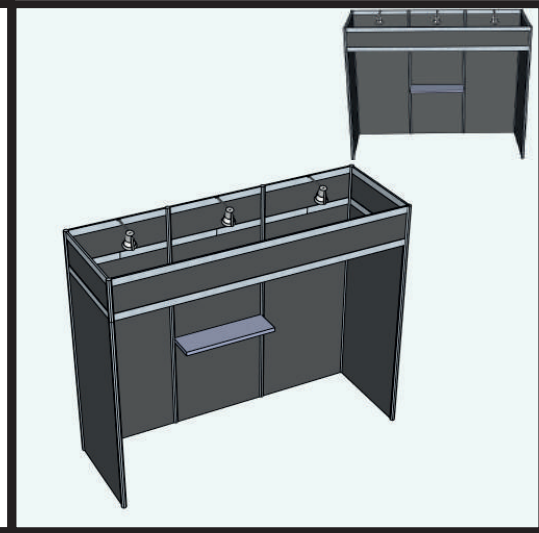

10'x10' #3001

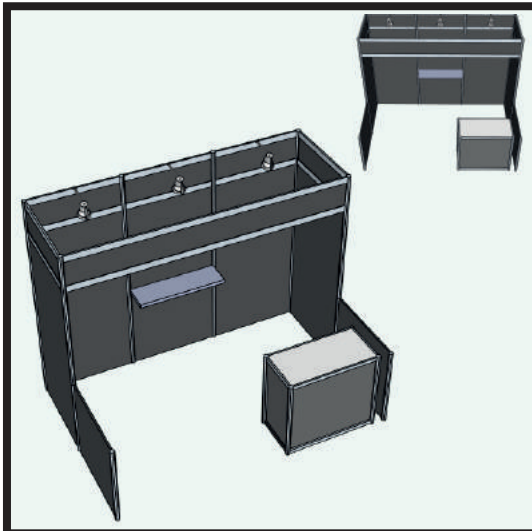

10'x10' #3002

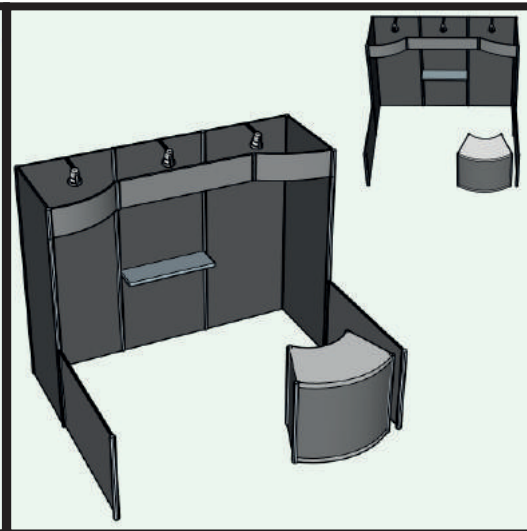

10'x10' #3002A

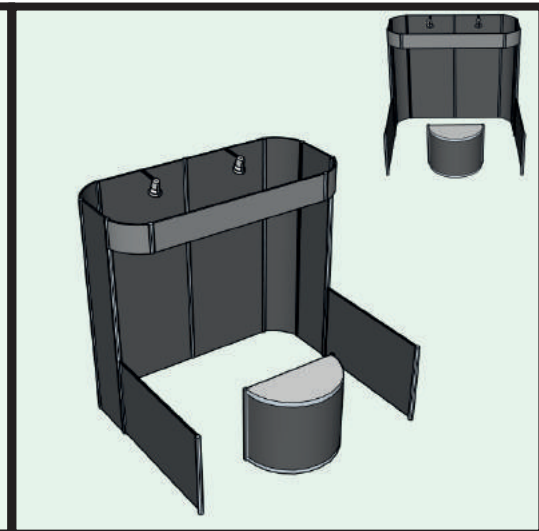

10'x10' #3011

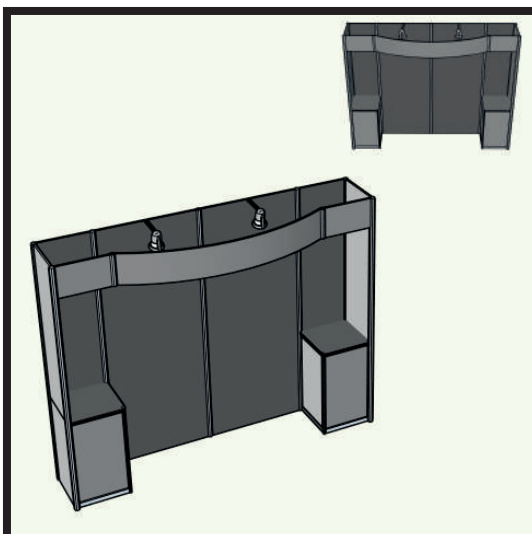

10'x10' #3012

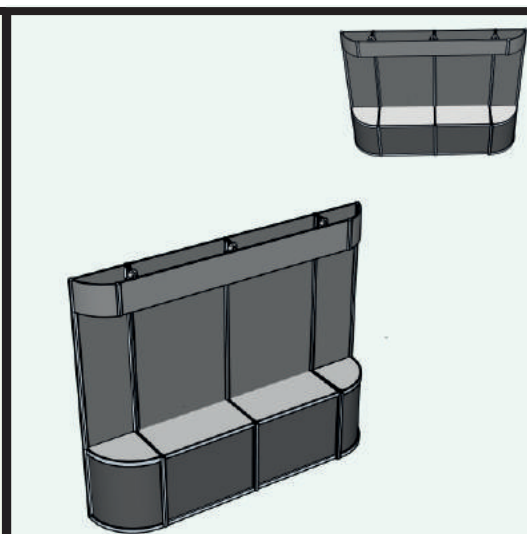

10'x10' #3013

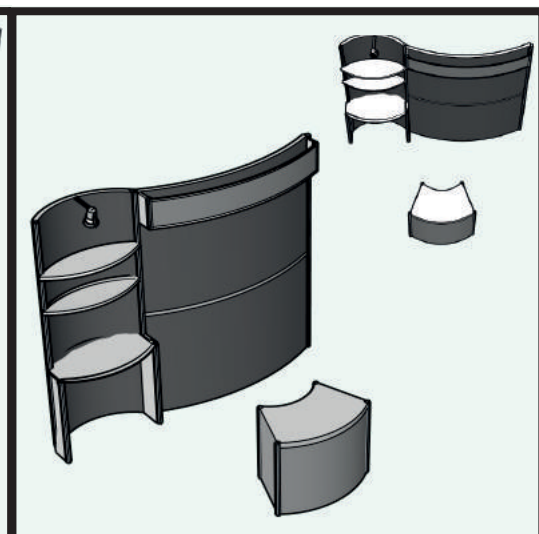

10'x10' #3014



1921 Bellamah NW
Albuquerque, NM 87104
t. 505.243.9889
f. 505.243.8197
www.cssabq.com

email us @
esr@cssabq.com

RENTAL DISPLAY UNITS

10X20

CONVENTION SERVICES OF THE SOUTHWEST, INC.



10'x20' #3003

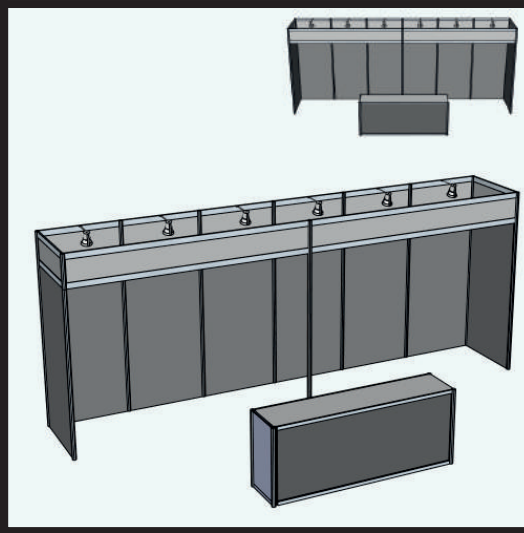

10'x20' #3004

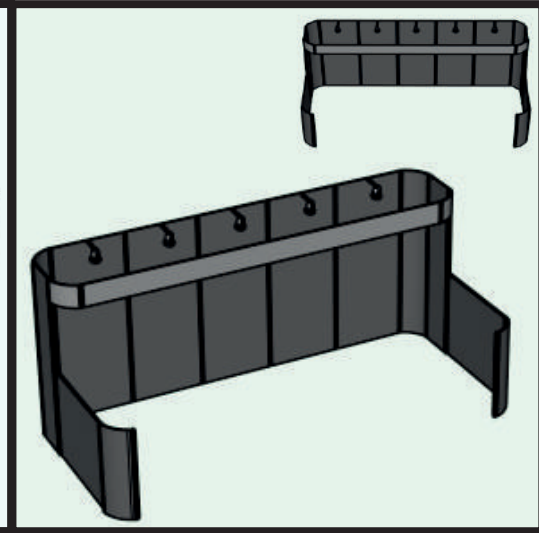

10'x20' #3020

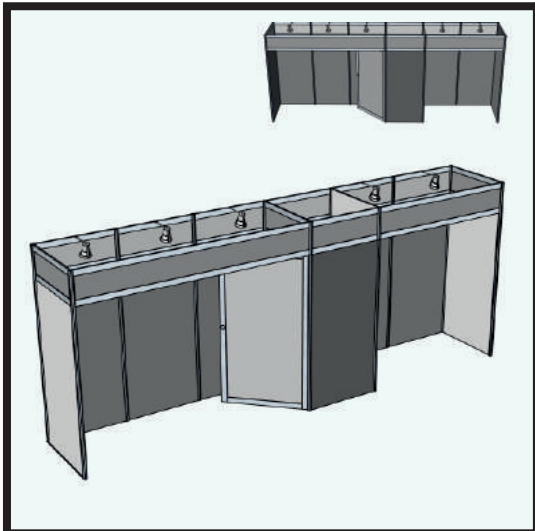

10'x20' #3005

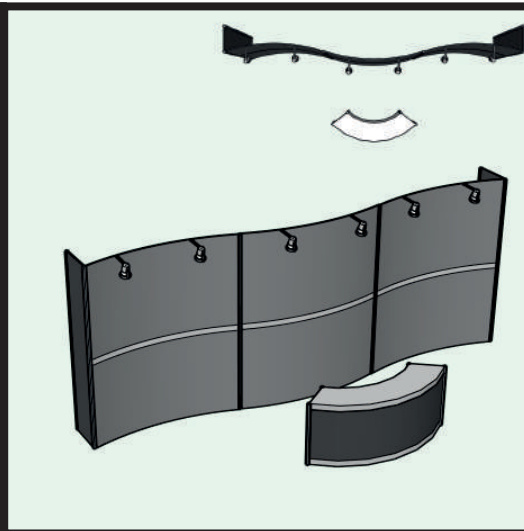

10'x20' #3021

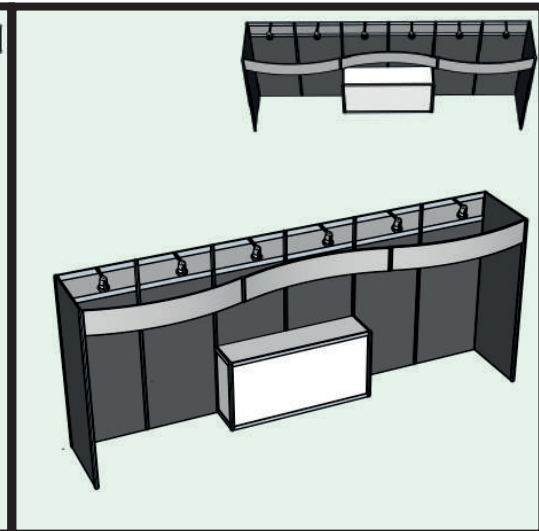

10'x20' #3022

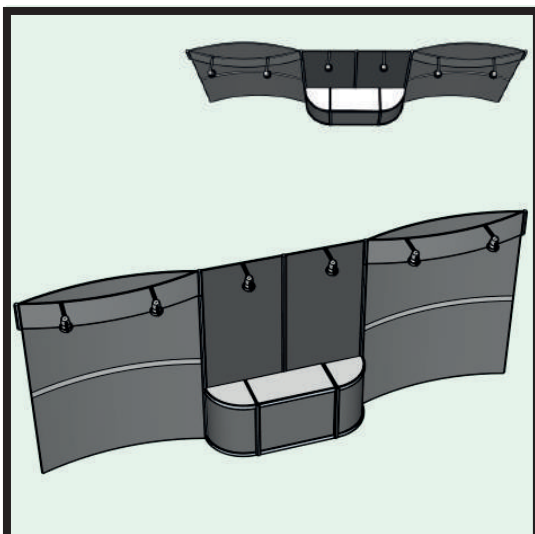

10'x20' # 3023

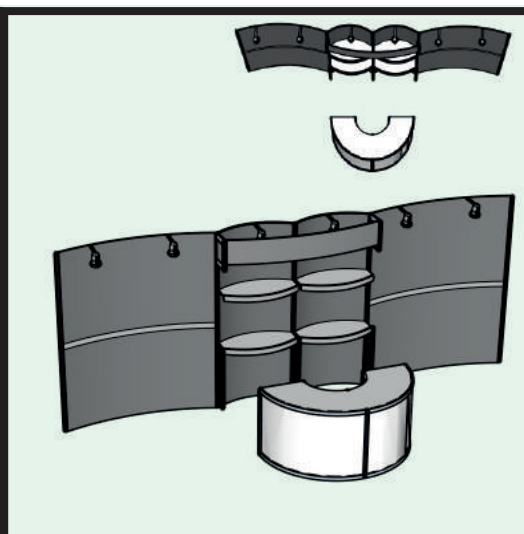

10'x20' #3024

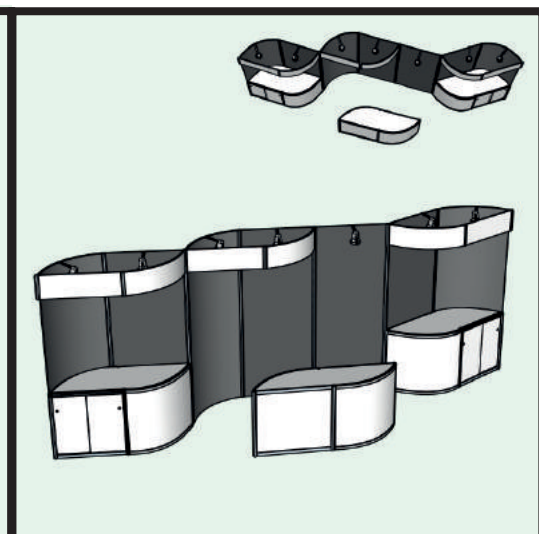

10'x20' #3025



1921 Bellamah NW
Albuquerque, NM 87104
t. 505.243.9889
f. 505.243.8197
www.cssabq.com

email us @
esr@cssabq.com

RENTAL DISPLAY UNITS COUNTERS

CONVENTION SERVICES OF THE SOUTHWEST, INC.

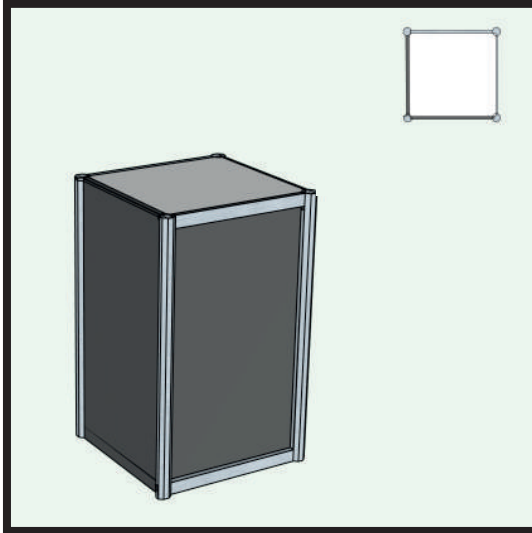

WHITE PEDESTAL

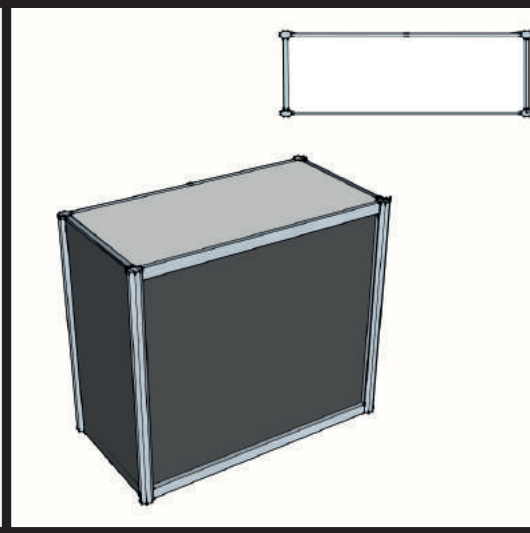

1 METER COUNTER

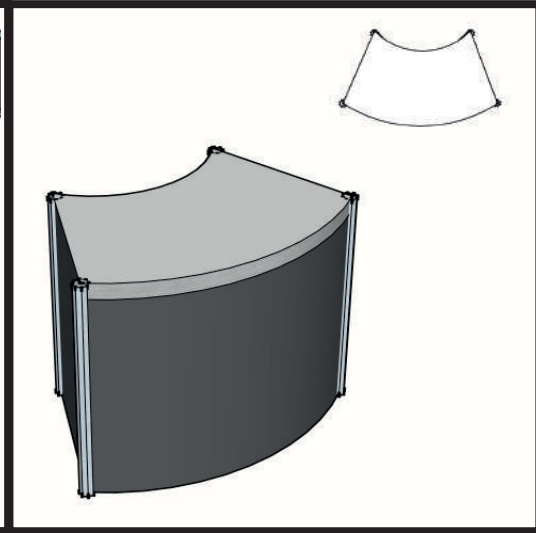

1/4 ROUND COUNTER

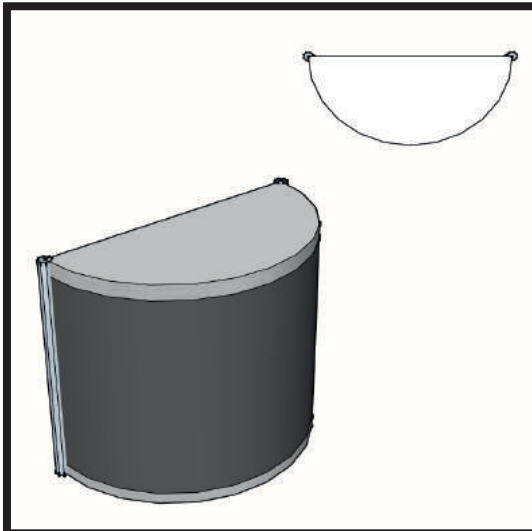

1 METER CURVED COUNTER

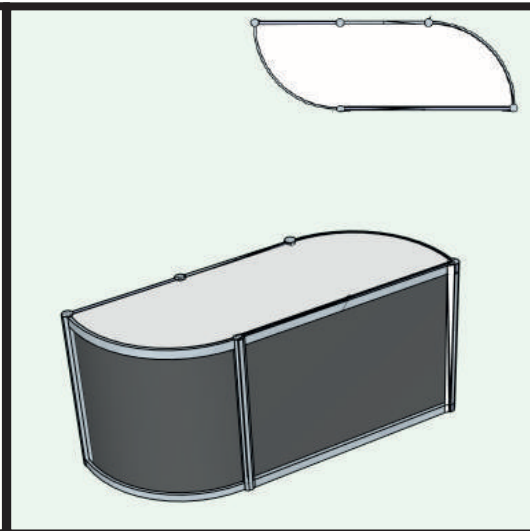

1.5 METER COUNTER WITH CURVES

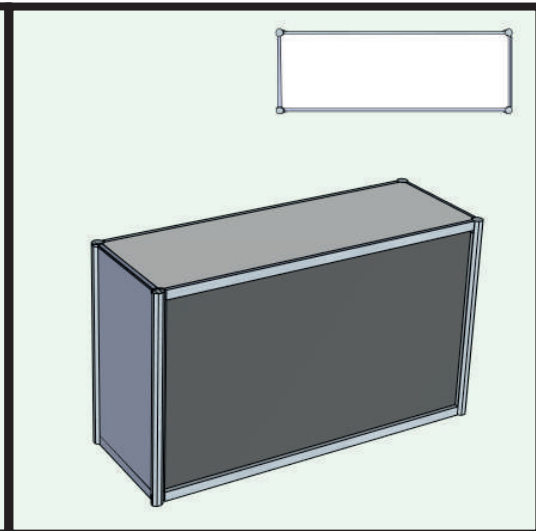

2 METER COUNTER

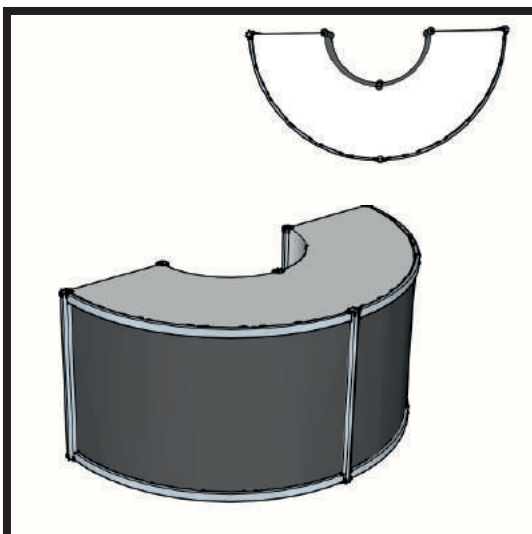

1/2 ROUND COUNTER

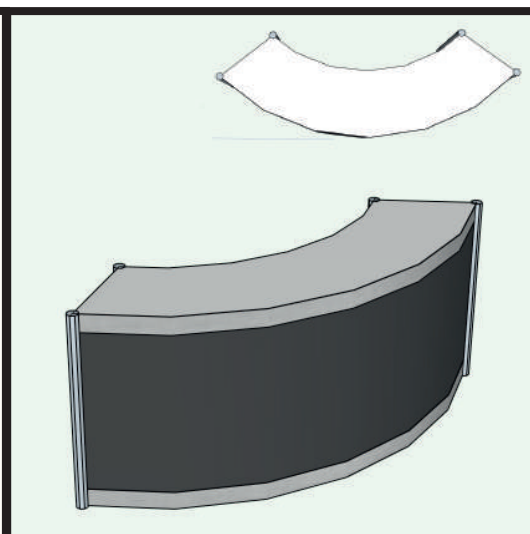

2 METER RADIUS COUNTER

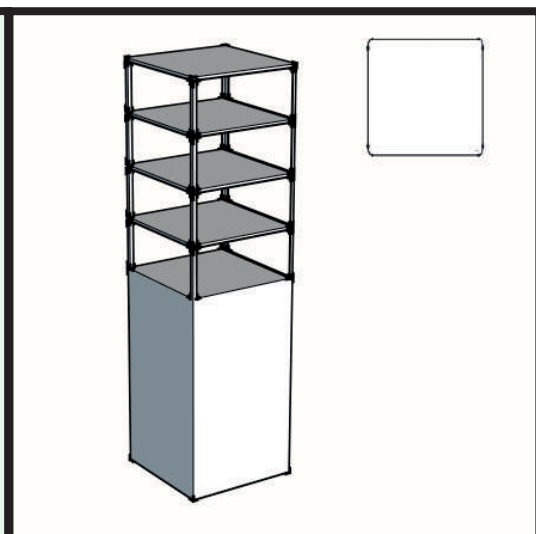

VERTICAL GLASS DISPLAY



1921 Bellamah NW
 Albuquerque, NM 87104
 t. 505.243.9889
 f. 505.243.8197
 www.cssabq.com

email us @
 esr@cssabq.com

LABOR ORDER FORM

CONVENTION SERVICES OF THE SOUTHWEST, INC.

Event Name: SWTA 2023	Advance Payment Deadline: Thursday, February 2, 2023	Booth # (s):
Company Name:	Telephone #:	
Billing Address:	Fax #:	
City/State/Zip:	Email Address:	
Authorized by:		

Display labor & Forklift will be billed in 1/2 hour increments with a **one-hour minimum**.

DISPLAY LABOR RATES	Advance Price Per Person / Per Hour	Standard Price Per Person / Per Hour
Straight time – 8:00AM – 4:30PM (Weekdays)	\$121.00	\$145.00
Overtime – Before 8:00AM and after 4:30PM (Weekdays & Saturdays)	\$171.00	\$195.00
Sundays and Holidays	\$221.00	\$245.00

FORKLIFT RATES WITH OPERATOR	Advance Price Per Person / Per Hour	Standard Price Per Person / Per Hour
Straight time – 8:00AM – 4:30PM (Weekdays)	\$216.00	\$259.00
Overtime – Before 8:00AM and after 4:30PM (Weekdays & Saturdays)	\$266.00	\$309.00
Sundays and Holidays	\$316.00	\$359.00

****Exhibitor must contract all forklift operation with the official service contractor.****

SUPERVISION OF ALL LABOR IS REQUIRED. PLEASE INDICATE SUPERVISION PLAN:

PLAN A - EXHIBITOR SUPERVISION

All work is performed under the supervision of the Exhibitor. Starting time can be guaranteed only in those instances where persons are requested for the start of the working day, 8:00AM. If labor is not picked up or canceled without 24-hour's notice, your estimated labor hours will be charged. **The exhibitor must check in at the service desk to pick up labor ordered and check labor out at the service desk, upon completion of the work. If display materials have not arrived by scheduled labor install times, your estimated labor hours will be charged.**

Representative Name/Company

PLAN B – CSS SUPERVISION

***Please fill out all outbound shipping information.

All work is performed under the direction of **CSS** personnel. Our charge for this service is 30% of your total labor bill (**\$50 minimum**). In order to complete the work without your representative present, we must have set-up instructions (blueprints/floor plans, etc.). **If display materials have not arrived by scheduled labor install times, your estimated labor hours will be charged. You must also include outbound shipping labels and shipping instructions with your labor order.**

Please complete this section:

	Labor Type	No. of People	Date	Time	Approximate Hours	Estimated Cost
INSTALLATION						
DISMANTLE						

PLEASE READ PAYMENT POLICY

SUBTOTAL	\$
Forklift Tax (8.5%)	\$
TOTAL	\$



1921 Bellamah NW
Albuquerque, NM 87104
t. 505.243.9889
f. 505.243.8197
www.cssabq.com

email us @
esr@cssabq.com

LABOR JURISDICTIONS

Denver Area, Colorado

CONVENTION SERVICES OF THE SOUTHWEST, INC.

UNION JURISDICTIONS FOR THE DENVER AREA, COLORADO

THE FOLLOWING GUIDELINES APPLY IN THE DENVER AREA, COLORADO:

We are certain you will appreciate knowing in advance that union labor may be required for certain aspects of your exhibit handling. To help you understand the jurisdiction that the various unions have, we ask that you read the following:

CONVENTION, DISPLAY, TRADE SHOW LABOR CONDITIONS

All decorating, display, drayage, theatrical, rigging, production, audio visual, commercial presentations as well as all material handling for conventions, trade shows, promotional displays, and consumer shows are performed by the Denver Theatrical Stage Employees Union, IATSE, Local No 7.

EXHIBIT INSTALLATION AND DISMANTLING

Full time employees of an exhibiting firm may install and dismantle their own respective company display, if such work can be completed in less than 60 minutes and without the use of mechanized tools.

Any outside or additional labor required for installation, dismantle or decorating of displays is to be performed by the official General Service Contractor or by any other contractor signatory to the IATSE, Local 7 labor agreement.

MATERIAL HANDLING

Exhibitors may handle their own hand carried materials in and out of the Colorado Convention Center. Any material requiring the use of equipment for delivery, i.e., dollies or forklifts, will be handled by labor through IATSE Local No 7. Equipment and labor is arranged through the General Service Contractor.

DOCK SPACE

Dock space is limited at the Colorado Convention Center and it is under the control and authority of the General Services Contractor.

SAFETY

Standing on chairs, tables, or other rental furniture is prohibited. This furniture is not engineered to support your standing weight. **CSS** cannot be responsible for injuries or falls caused by the improper use of this furniture. If assistance is required in assembling your booth, please order labor on the Display Labor order form and the necessary ladders and tools will be provided.

GRATUITIES

Our work rules prohibit the SOLICITATION OR ACCEPTANCE of tips in cash, product or gifts of any kind by any employee (union or non-union). Our employees are paid appropriate wages denoting professional status, therefore tipping of any kind is not allowed.

IN GENERAL

- Trades people have been instructed to refrain from expressing any grievance or directly challenging the practice of any Exhibitor. All questions originated by labor are to be expressed to the supplier of that labor and/or **CSS** Management. Direct any questions in regards to union claimed jurisdictions or practices to **CSS** Management.
- If you encounter any difficulty with any laborer, or if you are not satisfied with the work performed, please bring this to the attention of **CSS**. Please refrain from voicing complaints directly to craft personnel.
- The person in charge of your exhibit should carefully inspect and sign all work order forms. If there are any questions about any bills, bring the bill to the appropriate Service Desk and discuss it with the person in charge.



1921 Bellamah NW
 Albuquerque, NM 87104
 t. 505.243.9889
 f. 505.243.8197
 www.cssabq.com

email us @
 esr@cssabq.com

EXHIBITOR APPOINTED CONTACTOR (EAC)
 Submission Deadline for Notification & Certificate of Insurance: **Mon, January 23, 2023**

CONVENTION SERVICES OF THE SOUTHWEST. INC.

EXHIBITORS WHO CHOOSE TO HAVE AN EXHIBIT SERVICE FIRM (OTHER THAN THE OFFICIAL LABOR CONTRACTOR) SUPERVISE LABOR, UNPACK, ERECT, ASSEMBLE, DISMANTLE, AND PACK DISPLAYS / EQUIPMENT MUST ABIDE BY THE FOLLOWING:

- Exhibitor must notify Show Management and Convention Services of the Southwest (CSS) in writing no later than **Monday, January 23, 2023**.
- Exhibitor must ensure their contractor (EAC) provides CSS with a Certificate of Insurance indicating a minimum of \$1,000,000 liability coverage, including property damage, and naming CSS as additional insured by **Monday, January 23, 2023**. If this certificate is not received by the deadline date, Exhibitor may send in a supervisor only and will be required to order show labor. If CSS does not receive a certificate by move-in, the EAC will not be permitted on the show floor.
- Exhibitor is ultimately responsible for all services in connection with their exhibit, including freight, drayage, rentals, labor, etc. Companies who leave garbage in aisles or have excessive giveaway boxes will be mandated daily cleaning.
- The EAC must have all business licenses, permits, and Workers' Compensation insurance required by the State and/or City governments and the facility management prior to beginning work. The EAC shall provide evidence of compliance upon request, and must be compliant with all union jurisdictions.
- The EAC shall share with CSS all reasonable costs incurred as a result of/relating to the EAC's operation, including overtime pay for stewards, restoration of exhibit space to its initial condition, trash removal, etc.
- The EAC must provide CSS and Show Management the names of all personnel who will be working on the show floor. All personnel are required to wear identification badges at all times and shall comply with all facility badging requirements. Anyone without proper ID will be asked to leave the show floor.
- The EAC may not, under any circumstances solicit business on the show floor.
- The EAC must confine its operations to the exhibit area of its clients; no service desk, storage areas, or other work facilities shall be located within the building. (Show aisles and public space are not part of the booth area.)
- Upon request, the EAC shall provide evidence that it possesses applicable and current labor contracts and must comply with all collective bargaining regulations and agreements.
- The Official Contractor has total control over such services as electrical, plumbing, telephone, cleaning, drayage, etc. Exhibitors shall provide only the material they own and is to be used in their exhibit space.

NAME OF EXHIBITOR APPOINTED CONTRACTOR:	
ADDRESS:	
CONTACT, TELEPHONE # & FAX:	

The EAC must notify CSS of the names of all exhibiting companies for whom they have orders and the names of all employees working for them on the show floor. All EACs must provide insurance certificates to CSS and Show Management of the exhibition. Please list show name, location, and Exhibitor name on Certificate of Insurance. **Exhibitor Appointed Contractors will not have access to the show floor without a Certificate of Insurance on file with CSS.**

COMPANY:	BOOTH:
ADDRESS:	CONTACT NAME:
CITY:	SIGNATURE:
STATE: ZIP:	PHONE:
EMAIL:	FAX:



1921 Bellamah NW
 Albuquerque, NM 87104
 t. 505.243.9889
 f. 505.243.8197
 www.cssabq.com

email us @
 esr@cssabq.com

VEHICLE SPOTTING ORDER FORM

Mobile Units / Motorized Vehicles

CONVENTION SERVICES OF THE SOUTHWEST, INC.

Event Name: SWTA 2023	Advance Payment Deadline: Thursday, February 2, 2023	Booth # (s):
Company Name:	Telephone #:	
Billing Address:	Fax #:	
City/State/Zip:	Email Address:	
Authorized by:		

DIRECT MOBILE UNITS / MOTORIZED VEHICLES / EXHIBIT AREA

Exhibitors or agents with mobile or motorized equipment will require guidance to their respective booths. This guidance is required and provided by **CSS** to prevent damage that may occur to exhibits, or property of others, or when necessary to move crates that may be in aisles.

Exhibitors may drive their motorized equipment in and out of the exhibit areas with **CSS** spotters, or have **CSS** supply an operator when available.

Mobile units are to have 1/4 tank of gas or less and once vehicle is in place, battery is to be disconnected, gas cap locked or taped.

EXHIBIT AREA:

MOBILE UNITS

\$ 250 PER UNIT (Round Trip)

Number of Units: _____ Type: _____

Dimensions of Largest Unit:

Height: _____ Width: _____ Length: _____ Weight: _____

Comments/Special Handling Requirements: _____

PLEASE READ PAYMENT POLICY

SUBTOTAL	\$
Tax Exempt	\$ _____
TOTAL	\$



CONVENTION SERVICES OF THE SOUTHWEST, INC.

MATERIAL HANDLING (DRAYAGE) INFORMATION

- ❖ As an exhibitor, you are responsible for providing your carrier with proper delivery and pickup information for your materials, both in advance and at show site.
- ❖ Please prepay all shipping charges. **CSS** cannot accept or be responsible for collect shipments. Keep in mind, **material handling** (drayage) charges and shipping charges are not the same thing.
 - “Drayage” is the movement of freight from decorator warehouse or show-site dock to exhibit booth and back out to the “freight carrier” at the show-site dock.
 - “Shipping” is movement of freight from city to city on a designated carrier.
- ❖ All shipments must be accompanied by a bill of lading. Shipments received without receipts, freight bills, or specified unit counts (UPS, Federal Express, personal vehicles, etc.) will be delivered to the exhibitor’s booth without guarantee of piece count or condition. No liability will be assumed by **CSS** for such shipments. Shipments without certified weight documents will be estimated by **CSS**. *(*This estimate will be binding on both parties and no adjustments will be made after the show closes.)*
- ❖ **We will accept all cartons, crates, and skidded materials at the warehouse. Do not ship uncrated materials to the warehouse. Loose materials, uncrated materials, or machinery not banded to skids will be accepted at show site only.**
- ❖ **All van line shipments must be accompanied by a “certified weight ticket”, with heavy & light weights otherwise CSS will estimate freight weight, which will be binding on both parties and no adjustments will be made after the show closes.**
- ❖ All shipments for the show received either in advance or at show site will be assessed material handling charges by **CSS**. *(Please refer to the **Material Handling Rate Sheet**.)* All material handling rates are roundtrip and are based on incoming weights only. Overtime charges may apply under some circumstances, such as carrier-delayed freight delivered after designated move-in times.
- ❖ “Off-Target” freight is when freight arrives at the advance warehouse prior to the first scheduled day or after the last scheduled day indicated on both the show information sheet and the Material Handling Rate Sheet. If freight is delivered prior to the first scheduled day of advance freight receipt, storage charges may apply. If freight is delivered after the last scheduled day of advance freight receipt, additional delivery charges may apply.

MATERIAL HANDLING INCLUDES:

- Storing your booth, equipment, and materials in our warehouse for up to 30 days in advance of the show. *(Advance shipments only)*
- Delivering materials to your booth at show site.
- Removing empty containers from your booth, storing them for the duration of the show, then returning them to your booth at close of show.
- Moving packed and labeled materials from your booth to the dock area at close of show and reloading them on designated carriers based on information provided on your show site bill of lading (obtained from **CSS** Service Center).

MATERIAL HANDLING DOES NOT INCLUDE:

- Labor and/or equipment for uncrating, unskidding, assembling, positioning, leveling, dismantling, re-crating, and reskidding machinery and/or equipment for exhibitors. Additional labor to accomplish these tasks may be ordered from the **Labor Order Form** enclosed in the Exhibitor Service Kit.
- Scheduling any carrier for pick-up or delivery of your materials, if other than the official show carrier(s). All carriers must be checked in by the designated re-routing time or exhibitor freight will be either re-routed with show carrier or returned to **CSS** warehouse at exhibitor expense. Please refer to **Material Handling Rate Sheet** for re-route times.



1921 Bellamah NW
Albuquerque, NM 87104
t. 505.243.9889
f. 505.243.8197
www.cssabq.com

email us @
esr@cssabq.com

MATERIAL HANDLING INFORMATION & LIMITS OF LIABILITY

CONVENTION SERVICES OF THE SOUTHWEST, INC.

LIMITS OF LIABILITY

PLEASE READ:

CSS' liability is limited to physical loss or damage to a specific article which is lost or damaged, and in any event **CSS'** maximum liability will be limited to \$.30 per pound, per article with a maximum liability of \$50.00 per item or \$1,000.00 per shipment, whichever is less.

CSS will not be liable to any extent whatsoever for any actual, potential, or assumed loss of profits or revenues, or for any collateral costs, which may result from any loss or damage to an exhibitor's materials which may make it impossible or impractical to exhibit said materials.

Claims for loss or damage that are not submitted to **CSS** within 30 days of the close of the show shall be considered waived.

The consignment or delivery of a shipment to **CSS** by an exhibitor, or by any shipper on behalf of the exhibitor, will be construed as an acceptance by such exhibitors (and/or shippers) of the terms and conditions set forth in this document.

To expedite removal of materials from the show site, **CSS** shall have the authority to change designated carriers, if such carriers do not pick-up on time. Where the exhibitor makes no disposition, materials will be either taken to a warehouse to await exhibitor's shipping instructions (in which case "return to the warehouse" charges will be incurred by exhibitor) or shipped to the exhibitor's address. Labeled shipments left in the facility at the close of the show without a bill of lading will be re-routed with the preferred carrier. No liability will be assumed as a result of such re-routing or handling.

INSURE ALL SHIPMENTS FROM THE TIME THEY LEAVE YOUR COMPANY UNTIL THEY ARE RETURNED FROM THE SHOW. Your present insurance carrier can add a rider to your current policy.

IT IS THE RESPONSIBILITY OF THE EXHIBITOR TO MAKE ALL ARRANGEMENTS FOR PICK-UP AND DELIVERY OF FREIGHT. IF YOU CHOOSE TO USE OUR PREFERRED CARRIER, WE WILL MAKE ALL OUTBOUND ARRANGEMENTS FOR YOU. A COMPLETED BILL OF LADING WILL STILL BE REQUIRED.

CSS will not be responsible for:

- Shipments delivered to the wrong booth due to improper labeling by the exhibitor.
- Misdirected shipments or removal of crates to storage due to old labels appearing on crates.
- Damage to uncrated or improperly packed materials, or concealed damage.
- Loss, theft, or disappearance of Exhibitor's material after it has been delivered to the exhibit booth.
- Loss, theft, or disappearance of Exhibitor's material prior to materials being picked up from exhibit booths for reloading after close of the show. **CSS** will check all bills of lading covering outgoing shipments at time of actual pick up from the exhibit booth. Corrections will be made to the bill of lading where discrepancies occur.
- Loss, damage, or delay due to fire, acts of God, strikes, lockouts, work stoppages of any kind, or any causes beyond **CSS** control.

The exhibitor accepts the responsibility for the payment of charges in connection with the handling of the shipment and guarantees payment to CSS for the incurred services described herewith. SEE PAYMENT POLICY.



1921 Bellamah NW
Albuquerque, NM 87104
t. 505.243.9889
f. 505.243.8197
www.cssabq.com

email us @
esr@cssabq.com

MATERIAL HANDLING AGREEMENT RATE SHEET AND ORDER FORM

CONVENTION SERVICES OF THE SOUTHWEST, INC.

Event Name: SWTA 2023	Advance Payment Deadline: Thursday, February 2, 2023	Booth # (s):
Company Name:	Telephone #:	
Billing Address:	Fax #:	
City/State/Zip:	Email Address:	
Authorized by:		

YOU ARE ENTERING A CONTRACT WHICH LIMITS YOUR POSSIBLE RECOVERY IN CASE OF LOSS OR DAMAGE. Acceptance of CSS' payment policy, material handling terms and conditions, and limits of liability will be construed when any of the following conditions are met: This Material Handling Agreement (MHA) is signed; Exhibitor's materials are delivered to CSS's warehouse or to an event site for which CSS is the Official Show Contractor; or an order for labor and/or rental equipment is placed by Exhibitor with CSS.

ADVANCE FREIGHT RECEIVING Monday – Friday 8:00AM – 4:00PM Monday, January 23 – Monday, February 20, 2023 ADVANCE SHIPPING ADDRESS	
Ship To:	Exhibitor Name and Booth # SWTA 2023 c/o CSS YRC Denver - 890 14700 Smith Road Aurora, CO 80011
Number of Pieces:	Estimated Weight:
Inbound Freight Carrier:	

FIRST DAY FOR DIRECT FREIGHT Wednesday, February 22, 2023 --- 8:00AM – 5:00PM DIRECT SHIPPING ADDRESS	
Ship To:	Exhibitor Name and Booth # c/o CSS SWTA 2023 Gaylord Convention Ctr Dock – Hall 1 6700 North Gaylord Rockies Blvd Aurora, CO 80019
Number of Pieces:	Estimated Weight:
Inbound Freight Carrier:	

Our preferred freight carrier is: CSS Logistics (505) 243-9889

****Freight will be re-routed from show floor on Friday, February 24, 2023 @ 2:00PM****

SAMPLE: Weight <u>500</u> ÷ 100 = Total CWT <u>5</u> @ <u>\$ 120</u> per cwt = <u>\$ 600</u>

ADVANCE FREIGHT RATES: (includes crates, skidded, and carton materials)

\$ 120 per cwt. \$ 240 minimum charge
Weight _____ ÷ 100 = Total CWT _____ @ \$ 120 per cwt = \$ _____

DIRECT FREIGHT RATES: (includes crates, skidded, and carton materials)

\$ 109 per cwt. \$ 218 minimum charge
Weight _____ ÷ 100 = Total CWT _____ @ \$ 109 per cwt = \$ _____

All charges are per hundred pounds (cwt) with a 200 lb. minimum per shipment. All shipments are rounded to the next hundred pounds.

ADDITIONAL RATES:

“Late Shipments” and “Off Target” freight will be charged an **additional \$24 per cwt.** (200 lb. minimum applies)

“Small Package” or shipments weighing 30 lbs. or less will be charged a **\$67 material handling fee.**

Banding and Shrink Wrap will be charged at **\$78** per skid or crate.

Outbound Material Handling Only (freight handled at close of show only) will be charged **\$65 per cwt.** (200 lb. minimum applies)

PLEASE READ PAYMENT POLICY

SUBTOTAL	\$ _____
Tax Exempt	\$ -----
TOTAL	\$ _____

ADVANCE WAREHOUSE SHIPPING LABELS



ADVANCE WAREHOUSE

CONVENTION SERVICES OF THE SOUTHWEST, INC.

TO: _____
(Exhibiting Company Name)

BOOTH #: ____ NO. ____ of ____ PCS

SWTA 2023

c/o CSS

YRC Denver - 890
14700 Smith Road
Aurora, CO 80011

Warehouse Hours: M-F - 8:00AM-4:00PM

MUST ARRIVE BY: Mon., Feb. 20, 2023

RUSH



ADVANCE WAREHOUSE

CONVENTION SERVICES OF THE SOUTHWEST, INC.

TO: _____
(Exhibiting Company Name)

BOOTH #: ____ NO. ____ of ____ PCS

SWTA 2023

c/o CSS

YRC Denver - 890
14700 Smith Road
Aurora, CO 80011

Warehouse Hours: M-F - 8:00AM-4:00PM

MUST ARRIVE BY: Mon., Feb. 20, 2023

RUSH

DIRECT SHIPPING LABELS



DIRECT TO SHOW

CONVENTION SERVICES OF THE SOUTHWEST, INC.

TO: _____
(Exhibiting Company Name)

BOOTH #: ____ NO. ____ of ____ PCS

SWTA 2023

c/o CSS

Gaylord Convention Ctr Dock – Hall 1
6700 North Gaylord Rockies Blvd
Aurora, CO 80019

Must NOT arrive before 2/22/23

DIRECT Shipments Received:

Wednesday, February 22, 2023

8:00 AM – 5:00 PM

RUSH



DIRECT TO SHOW

CONVENTION SERVICES OF THE SOUTHWEST, INC.

TO: _____
(Exhibiting Company Name)

BOOTH #: ____ NO. ____ of ____ PCS

SWTA 2023

c/o CSS

Gaylord Convention Ctr Dock – Hall 1
6700 North Gaylord Rockies Blvd
Aurora, CO 80019

Must NOT arrive before 2/22/23

DIRECT Shipments Received:

Wednesday, February 22, 2023

8:00 AM – 5:00 PM

RUSH



1921 Bellamah NW
 Albuquerque, NM 87104
 t. 505.243.9889
 f. 505.243.8197
 www.cssabq.com

email us @
 esr@cssabq.com

OUTBOUND SHIPPING INFORMATION

CONVENTION SERVICES OF THE SOUTHWEST, INC.

Event Name: SWTA 2023	Advance Payment Deadline: Thursday, February 2, 2023	Booth # (s):
Company Name:	Telephone #:	
Billing Address:	Fax #:	
City/State/Zip:	Email Address:	
Authorized by:		

EVERY OUTBOUND SHIPMENT WILL REQUIRE A **CSS** BILL OF LADING AND LABELS. WE WOULD BE HAPPY TO PREPARE THESE FOR YOU IN ADVANCE AND WILL HAVE THEM AVAILABLE AT THE **CSS** SERVICE DESK FOR YOU TO REVIEW AND SIGN. TO TAKE ADVANTAGE OF THIS SERVICE, PLEASE COMPLETE AND RETURN THIS FORM.

*This form is required when labor is **CSS** supervised.*

SHIPPING INFORMATION (IMPORTANT: If your freight is forwarding to another show, be sure to include the show name and your booth number):

FROM: SHIPPER/EXHIBITOR NAME: _____
 BILLING ADDRESS: _____

 CITY: _____ STATE: _____ ZIP: _____

TO: COMPANY NAME: _____
 DELIVERY ADDRESS: _____

 CITY: _____ STATE: _____ ZIP: _____
 PHONE#: _____ ATTN: _____
 SPECIAL INSTRUCTIONS: _____

METHOD OF SHIPMENT Please specify your choice by checking the following:

- The preferred carrier, **CSS Logistics**, is authorized to ship show materials to the above address.
(Must complete/include CSS Logistics forms.)
- The assigned carrier **PRE-SCHEDULED (by exhibitor)** to pick-up during show move-out is:
(Please note the Exhibitor is responsible for scheduling carriers other than CSS Logistics.)
 - Common Carrier _____
 - Van Line _____
 - Air Freight _____

NUMBER OF DESIRED SHIPPING LABELS: _____ *(Fed Ex and UPS shipping labels are not available)*

- Once your shipment is packed and ready to be picked up, please return the BOL to the Exhibitor Services Center.
- Verify the piece count, weight, and that a signature is on the BOL prior to shipping out.
- Shipments without paperwork turned in will either be returned to our warehouse, or shipped through CSS Logistics at Exhibitor's expense.

KEEP IT SIMPLE

CSS LOGISTICS, LLC

For ALL your Tradeshow Freight Needs



Ground

Air

Domestic Only

- Discounted Show Freight Rates
- Time Critical
- Automatic Tracking Notification upon request
- No Detention Charges – Outbound Ground
- No additional charges for weekend/after hours pickups
- Bill of Ladings and shipping labels emailed to you



CSS LOGISTICS, Inc
1921 Bellamah NW
Albuquerque, NM 87104
p. 505.243.9889
f. 505.243.8197
CSSL@cssabq.com



1921 Bellamah NW
 Albuquerque, NM 87104
 t. 505.243.9889
 f. 505.243.8197
 www.cssabq.com

email us @
 CSSL@cssabq.com

KEEP IT SIMPLE
5% Show Discount on Round Trip Freight
 (over show special weight of 140lbs)

L O G I S T I C S

CSS Logistics, Inc. is the preferred show carrier for Convention Services of the Southwest, Inc. We specialize in addressing the unique needs of tradeshow exhibitors, both behind the scenes and on the show floor.

RE: 2023 SWTA Annual Transit Conference & Expo
 Gaylord Rockies Resort & Convention Center
 Thursday, February 23 – Friday, February 24, 2023

Dear Exhibitor:

As the preferred carrier for CSS, we will take extra care in seamlessly moving your freight from point of origin to show, whether it ships to the advance warehouse or directly to the show floor.

We are offering a show special to ship to advance warehouse as well as from the show floor. This rate is deferred Ground Service to the Advance Warehouse and a credit card authorization form must be on file.

There is NO ADDITIONAL CHARGE for residential pick up/deliveries, lift gate requirements, fuel surcharges, and/or tradeshow overtime or detention fees. Charges are based on actual weight with additional charges only in cases of freight in excess of eight (8) linear feet.

CSS Logistics will not act as Importer of Record (IOR) or Ultimate Consignee and will not provide a Power of Attorney or FEIN numbers for international customs documentation.

SHOW SPECIAL

\$325.00 *each way*

Show Special Shipping is 3-14 Day Ground Deferred Transit Time depending on location.

Only applies to total shipping weight of up to 140lbs

All items handled by CSS are subject to Material Handling charges regardless of carrier or weight.

Please contact CSS for Material Handling requirements for your show at esr@cssabq.com

You pack-n-wrap

We provide labels and shipping documents

Ordering couldn't be simpler. There are two order forms attached for your convenience: One to ship to the advance warehouse and one to ship out at the end of the show. Complete the applicable information (greyed areas have been filled out for you), credit card authorization, and initial the limits of liability document (this is required), fax or email back, and we'll do the rest!

Thank you for your business!



1921 Bellamah NW
Albuquerque, NM 87104
t. 505.243.9889
f. 505.243.8197
www.cssabq.com

email us @
CSSL@cssabq.com

ORDER FORM

SHIP TO ADVANCE WAREHOUSE

L O G I S T I C S

SHIP DIRECT TO ADVANCE WAREHOUSE

Show Name: **SWTA 2023**

Booth #:

FREIGHT IS ACCEPTED FROM: Monday, January 23 – Monday, February 20, 2023 – M-F 8AM – 4PM

Company:

Contact Name and Phone #

Pick Up Address:

City: State: Zip:

Pick Up Date and TIME

Exhibitor:

Adv Whse Contact: Lorie Wrobel Phone: 505-243-9889

c/o CSS YRC Denver – 890

Address: 14700 Smith Road

City: Aurora State: CO Zip: 80011

SHIP BY GROUND (Circle One)

Standard Ground – 2-5 day week day transit, add 2 days for Pickup & Del

Time Critical – ships 1-2 days faster than standard and includes weekends

SHIP BY AIR (Circle Service Desired)

Overnight (Circle One): First AM AM PM

2nd Day Air (Circle One): AM Standard Delivery

SPECIAL SERVICES NEEDED/REQUESTED – IMPORTANT – CIRCLE Y or N IN EACH BOX

Home Pick Up/Delivery **Y / N** Lift Gate Required **Y / N** High Rise Office **Y / N** Limited Access **Y / N**

Dock Available **Y / N** Hazardous Materials **Y / N** Food **Y / N** Poison **Y / N**

If special services are required and not requested (e.g. site with no dock/limited access for 53' trailer; lift gate required; etc.), a missed pick up fee may apply.

No Pieces	Package Type CIRCLE ONE	Description of articles, special marks and exceptions	Dimensions			Est Weight
	Carton / Fiber / Crate / Skid		L	W	H	
	Carton / Fiber / Crate / Skid		L	W	H	
	Carton / Fiber / Crate / Skid		L	W	H	
	Carton / Fiber / Crate / Skid		L	W	H	

Limits of Liability for Loss and Damage are severely limited and based on weight not value. We highly recommend when shipping your materials to a tradeshow you speak with your insurance carrier to insure your equipment during transport and while on the show floor. Please note the attached Uniform Bill of Lading Terms and Conditions.

CREDIT CARD AUTHORIZATION

All Freight charges will be charged to the credit card below at time of weight verification and receipt of invoice from carrier. For Your convenience, we will use this authorization to charge your credit/debit card account for your advance orders, and any additional amounts incurred as a result of show side orders placed by your representative. These charges may include all CSS companies, or any charges which CSS may be obligated to pay on behalf of Exhibitor, including without limitation, any shipping charges. Please complete the information requested below.

Visa (begins w/4) MasterCard (begins w/5) American Express (begins w/3)

Credit Card #:

Expiration Date: CIV Code: Billing Zip Code:

Name on card / Signature

EMAIL (REQUIRED)

Date



1921 Bellamah NW
Albuquerque, NM 87104
t. 505.243.9889
f. 505.243.8197
www.csssabq.com

email us @
CSSL@cssabq.com

ORDER FORM

SHIP DIRECT TO TRADESHOW

L O G I S T I C S

SHIP DIRECT TO TRADESHOW (SHOW SITE)

Show Name: **SWTA 2023**

Booth #

FREIGHT IS ONLY ACCEPTED ON: Wednesday, February 22, 2023 – 8:00 AM – 5:00 PM

Company:

Contact Name and Phone #

Pick Up Address:

City: State: Zip:

Pick Up Date and TIME

Exhibitor:

C/O CSS Phone: 505-243-9889

Facility: Gaylord Rockies Ctr Loading Dock Hall 1

Address: 6700 North Gaylord Rockies Blvd

City: Aurora State: CO Zip: 80019

SHIP BY GROUND (Circle One)

Standard Ground – 2-5 day week day transit, add 2 days for Pickup & Del

Time Critical – ships 1-2 days faster than standard and includes weekends

SHIP BY AIR (Circle Service Desired)

Overnight (Circle One): First AM AM PM

2nd Day Air (Circle One): AM Standard Delivery

SPECIAL SERVICES NEEDED/REQUESTED – IMPORTANT – CIRCLE Y or N IN EACH BOX

Home Pick Up/Delivery **Y / N** Lift Gate Required **Y / N** High Rise Office **Y / N** Limited Access **Y / N**

Remote Pick Up/Delivery **Y / N** Hazardous Materials **Y / N** Food **Y / N** Poison **Y / N**

If special services are required and not requested (e.g. site with no dock/limited access for 53' trailer; lift gate required; etc.), a missed pick up fee may apply.

No Pieces	Package Type CIRCLE ONE	Description of articles, special marks and exceptions	Dimensions			Est Weight
	Carton / Fiber / Crate / Skid		L	W	H	
	Carton / Fiber / Crate / Skid		L	W	H	
	Carton / Fiber / Crate / Skid		L	W	H	
	Carton / Fiber / Crate / Skid		L	W	H	

Limits of Liability for Loss and Damage are severely limited and based on weight not value. We highly recommend when shipping your materials to a tradeshow you speak with your insurance carrier to insure your equipment during transport and while on the show floor. Please note the attached Uniform Bill of Lading Terms and Conditions.

CREDIT CARD AUTHORIZATION

All Freight charges will be charged to the credit card below at time of weight verification and receipt of invoice from carrier. For Your convenience, we will use this authorization to charge your credit/debit card account for your advance orders, and any additional amounts incurred as a result of show side orders placed by your representative. These charges may include all CSS companies, or any charges which CSS may be obligated to pay on behalf of Exhibitor, including without limitation, any shipping charges. Please complete the information requested below.

Visa (begins w/4) MasterCard (begins w/5) American Express (begins w/3)

Credit Card #:

Expiration Date: CIV Code: Billing Zip Code:

Name on card / Signature

EMAIL (REQUIRED)

Date



1921 Bellamah NW
Albuquerque, NM 87104
t. 505.243.9889
f. 505.243.8197
www.cssabq.com

email us @
CSSL@cssabq.com

ORDER FORM

RETURN FROM SHOW – GROUND ONLY

L O G I S T I C S

COMPLETE WHEN ORDERING OUTBOUND SERVICES (SHIPPING BACK FROM A SHOW)

Show Name: SWTA 2023	Booth #
-----------------------------	---------

Exhibiting Company:		
Facility: Gaylord Convention Ctr Dock – Hall 1		
Pick Up Address: 6700 North Gaylord Rockies Blvd.		
City: Aurora	State: CO	Zip: 80019

Ship TO (Consignee):		
Contact Name and Phone #:		
Address:		
City:	State:	Zip:

COMPLETE IF SHIPPING TO ANOTHER TRADESHOW: ALL Information Required to Schedule delivery		
DELIVERY INFORMATION REQUIRED: ADVANCE WHSE or DIRECT		
Delivery date: Not before _____ Not after _____		
Exhibiting Company:		
Show Name:	Booth #:	
C/O:	Phone #:	
Address:		
City:	State:	Zip:

SHOW SPECIAL RATES WILL SHIP DEFERRED GROUND

SPECIAL SERVICES NEEDED/REQUESTED – IMPORTANT – CIRCLE Y or N IN EACH BOX			
Home Pick Up/Delivery Y / N	Lift Gate Required Y / N	High Rise Office Y / N	Limited Access Y / N
Remote Pick Up/Delivery Y / N	Hazardous Materials Y / N	Food Y / N	Poison Y / N

No Pieces	Package Type CIRCLE ONE	Description of articles, special marks and exceptions	Dimensions	Est Weight
	Carton / Fiber / Crate / Skid		L W H	
	Carton / Fiber / Crate / Skid		L W H	
	Carton / Fiber / Crate / Skid		L W H	
	Carton / Fiber / Crate / Skid		L W H	

Limits of Liability for Loss and Damage are severely limited and based on weight not value. We highly recommend when shipping your materials to a tradeshow you speak with your insurance carrier to insure your equipment during transport and while on the show floor. Please note the attached Uniform Bill of Lading Terms and Conditions.

CREDIT CARD AUTHORIZATION

All Freight charges will be charged to the credit card below at time of weight verification and receipt of invoice from carrier. For Your convenience, we will use this authorization to charge your credit/debit card account for your advance orders, and any additional amounts incurred as a result of show side orders placed by your representative. These charges may include all CSS companies, or any charges which CSS may be obligated to pay on behalf of Exhibitor, including without limitation, any shipping charges. Please complete the information requested below.

Visa (begins w/4)
 MasterCard (begins w/5)
 American Express (begins w/3)

Credit Card #:

Expiration Date:
 CIV Code:
 Billing Zip Code:

Name on card / Signature	Date
EMAIL (REQUIRED)	



UNIFORM BILL OF LADING TERMS AND CONDITIONS

L O G I S T I C S

Sec 1

- (a) The carrier or the party in possession of any of the property described in this bill of lading shall be liable as at common law for any loss thereof or damage thereto, except as hereinafter provided:
- (b) No carrier shall be liable for any loss or damage to a shipment or for any delay caused by an Act of God, the public enemy, the authority of law, or the act or default of shipper. Except in the case of negligence of the carrier or party in possession, the carrier or party in possession shall not be liable for loss, damage or delay which results; when the property is stopped and held in transit upon request of the shipper, owner or party entitled to make such request; or from faulty or impassible highway, or by lack of capacity of a highway bridge or ferry; or from a defect or vice in the property; or from riots or strikes. The burden to prove freedom from negligence is on the carrier or the party in possession.

Sec 2

Unless arranged or agreed upon, in writing, prior to shipment, carrier is not bound to transport a shipment by a particular schedule or in time for a particular market, but is responsible to transport with reasonable dispatch. In case of physical necessity, carrier may forward a shipment via another carrier.

Sec 3

- (a) As a condition precedent to recovery, claims must be filed in writing with: any participating carrier having sufficient information to identify the shipment.
- (b) Claims for loss or damage must be filed within nine months after the delivery of the property (or, in the case of export traffic, within nine months after delivery at the port of export), except that claims for failure to make delivery must be filed within nine months after a reasonable time for delivery has elapsed
- (c) Suits for loss, damage, injury or delay shall be instituted against any carrier no later than two years and one day from the day when written notice is given by the carrier to the claimant that the carrier has disallowed the claim or any part or parts of the claim specified in the notice. Where claims are not filed or suits are not instituted thereon in accordance with the foregoing provisions, no carrier shall be liable, and such claims will not be paid.
- (d) Any carrier or party liable for loss of or damage to any of said property shall have the full benefit of any insurance that may have been effected, upon or on account of said property, so far as this shall not avoid the policies or contracts of insurance, PROVIDED, that the carrier received the benefit of such insurance will reimburse the claimant for the premium paid on the insurance policy or contract.

Sec 4

- (a) If the consignee refuses the shipment tendered for delivery by carrier or if carrier is unable to deliver the shipment, because of fault or mistake of the consignor or consignee, the carrier's liability shall then become that of a warehouseman. Carrier shall promptly attempt to provide notice, by telephonic or electronic communication as provided on the face of the bill of lading, if so indicated, to the shipper or the party, if any, designated to receive notice on the bill of lading. Storage may be, at the carrier's option, in any location that provides reasonable protection against loss or damage. The carrier may place the shipment in public storage at the owner's expense and without liability to the carrier.
- (b) If the carrier does not receive disposition instructions within 48 hours of the time of carrier's attempted first notification, carrier will attempt to issue a second and final confirmed notification. Such notice shall advise that if carrier does not receive disposition instructions within 10 days of that notification, carrier may offer the shipment for sale at a public auction and the carrier has the right to offer the shipment for sale. The amount of sale will be applied to the carrier's invoice for transportation, storage and other lawful charges. The owner will be responsible for the balance of charges not covered by the sale of goods. If there is a balance remaining after all charges and expenses are paid, such balances will be paid to the owner of the property sold hereunder, upon claim and proof of ownership.

- (c) Where carrier has attempted to follow the procedure set forth in Section 4, subsections 4(a) and (b) and the procedure provided in this section is not possible, nothing in this section shall be construed to abridge the right of the carrier at its option to sell the property under such circumstances and in such manner as may be authorized by law. When perishable goods cannot be delivered and disposition is not given within a reasonable time, the carrier may dispose of property to the best advantage.
- (d) Where a carrier is directed by consignee or consignor to unload or deliver property at a particular location where consignor, consignee, or the agent of either, is not regularly located, the risk after unloading or delivery shall not be that of the carrier.

Sec 5

- (a) In all cases not prohibited by law, where a lower value than the actual value of the said property has been stated in writing by the shipper or has been agreed upon in writing as the released value of the property as determined by the classification or tariffs upon which the rate is based, such lower value plus freight charges if paid shall be the maximum recoverable amount for loss or damage, whether or not such loss or damage occurs from negligence.
- (b) No carrier hereunder will carry or be liable in any way for any documents, coin money or for any articles of extraordinary value not specifically rated in the published classification or tariffs unless a special agreement to do so and stipulated value of the articles are endorsed on this bill of lading.

Sec 6

Every party, whether principal or agent, who ships explosives or dangerous goods, without previous full written disclosure to the carrier of their nature, shall be liable for and indemnify the carrier against all loss or damage caused by such goods. Such goods may be warehoused at owner's risk and expense or destroyed without compensation.

Sec 7

- (a) The consignor or consignee shall be liable for the freight and other lawful charges accruing on the shipment, as billed or corrected, except that collect shipments may move without recourse to the consignor when the consignor so stipulates by signature or endorsement in the space provided on the face of the bill of lading. Nevertheless, the consignor shall remain liable for transportation charges where there has been an erroneous determination of the freight charges assessed, based upon incomplete or incorrect information provided by the consignor.
- (b) Notwithstanding the provisions of subsection (a) above, the consignee's liability for payment of additional charges that may be found to be due after delivery shall be as specified by 49 U.S.C 13706, except that the consignee need not provide the specified written notice to the delivering carrier if the consignee is a for-hire carrier.
- (c) Nothing in this bill of lading shall limit the right of the carrier to require the prepayment or guarantee of the charges at the time of shipment or prior to delivery. If the description of articles or other information on this bill of lading is found to be incorrect or incomplete, the freight charges must be paid based upon the articles actually shipped.

Sec 8

- (a) If this bill of lading is issued on the order of the shipper, or his agent, in exchange or in substitution for another bill of lading, the shipper's signature on the prior bill of lading or in connection with the prior bill of lading as to the statement of value or otherwise, or as to the election of common law or bill of lading liability shall be considered a part of this bill of lading as fully as if the same were written on or made in connection with this bill of lading.

Sec 9

- (a) If all or any part of said property is carried by water over any part of said route, such water carriage shall be performed subject to the terms and provision and limitations of liability specified by the "Carriage of Goods By Sea Act" and any other pertinent laws applicable to water carriers.



1921 Bellamah NW
 Albuquerque, NM 87104
 t. 505.243.9889
 f. 505.243.8197
 www.cssabq.com

email us @
 CSSL@cssabq.com

DAMAGE/LOSS LIMITATIONS

L O G I S T I C S

IMPORTANT INFORMATION ON LIMITS OF LIABILITY

FREIGHT DAMAGE OR LOSS

TRANSPORTING (CSS LOGISTICS) AND WAREHOUSING (CSS)

TRANSPORTATION: Damage or loss occurs during the movement of your freight from one location to another using a common carrier. All claims are to be processed through the freight carrier.

CSS Logistics is a freight broker. We arrange freight pick up and deliveries between exhibitors and a common carrier – our preferred carriers are YRC and Associated Global Systems (AGS). As a broker, CSS Logistics assumes no liability for loss or damage.

WAREHOUSING: Damage or loss occurs after delivery prior to arrival at your booth.

Our Advance Warehouse locations outside of New Mexico carry warehouseman’s limits of liability which are typically between \$.30 – \$1.00 per pound depending on type of loss. New purchases (with proof of purchase) are the generally the higher amount. Some items such as exhibit booths over 5 years old, there is no recovery. All claims are filed with YRC.

CSS’ liability in Albuquerque, New Mexico is limited to physical loss or damage to a specific article which is lost or damaged, and in any event CSS’ maximum liability will be limited to \$.30 per pound, per article with a maximum liability of \$50.00 per item or \$1,000.00 per shipment, whichever is less. Claim must be made within 30 days of damage/loss. File your claim with CSS.

CSS will not be liable to any extent whatsoever for any actual, potential, or assumed loss of profits or revenues, or for any collateral costs, which may result from any loss or damage to an exhibitor’s materials which may make it impossible or impractical to exhibit said materials.

The consignment or delivery of a shipment to CSS by an exhibitor, or by any shipper on behalf of the exhibitor, will be construed as an acceptance by such exhibitors (and/or shippers) of the terms and conditions set forth in this document.

PLEASE INSURE YOUR TRADESHOW MATERIALS THROUGH YOUR EXISTING INSURANCE COMPANY.

Freight carriers do offer transportation insurance for new purchases. Quoted upon request.

I have read and understand the above terms and limits.

Print Name

Signature



1921 Bellamah NW
 Albuquerque, NM 87104
 t. 505.243.9889
 f. 505.243.8197
 www.cssabq.com

email us @
 esr@cssabq.com

CLEANING ORDER FORM

CONVENTION SERVICES OF THE SOUTHWEST, INC.

Event Name: SWTA 2023	Advance Payment Deadline: Thursday, February 3, 2022	Booth # (s):
Company Name:	Telephone #:	
Billing Address:	Fax #:	
City/State/Zip:	Email Address:	
Authorized by:		

CLEANING SERVICES (select only one of the services below)

SERVICES AVAILABLE		
Quantity (# of booths)	Description	Price
	Initial Cleaning (Vacuum & empty wastebasket(s) before first show day only)	\$.54 per sq. ft. (One Day)
	Daily Cleaning (Vacuum & empty wastebasket(s) for all show days)	\$.48 per sq. ft. (Daily)
	Daily Porter Service (Empty wastebasket(s) and periodic trash pick-up during show hours)	\$2.14 per sq. ft. (Daily)

PLEASE COMPUTE COST BELOW.

(To compute booth size: Length x Width)

NOTE: A MINIMUM OF 100 SQ. FT. WILL BE ASSESSED FOR TOTAL SQ. FT. AMOUNT.

# of Booths	X	Booth Size	=	Total sq. ft.	X	Rate per sq. ft.	X	# of Days	=	Subtotal
_____	X	_____	=	_____	X	_____	X	_____	=	_____

Companies who leave garbage in aisles or have excessive giveaway boxes will be mandated daily cleaning.

Please bring any discrepancies regarding these services to our attention prior to show close.
 CSS is unable to adjust invoices after the close of the show.

PLEASE READ PAYMENT POLICY

SUBTOTAL	\$
Tax (8.5%)	\$
TOTAL	\$



1921 Bellamah NW
 Albuquerque, NM 87104
 t. 505.243.9889
 f. 505.243.8197
 www.cssabq.com

email us @
 esr@cssabq.com

FLORAL ORDER FORM

CONVENTION SERVICES OF THE SOUTHWEST, INC.

Event Name: SWTA 2023	Advance Payment Deadline: Thursday, February 2, 2023	Booth # (s):
Company Name:	Telephone #:	
Billing Address:	Fax #:	
City/State/Zip:	Email Address:	
Authorized by:		

Quantity	Item	Advance Price	Standard Price	Total
	Floral Arrangement 12"H x 12"W	111	134	
	Floral Arrangement 18"H x 12"W	156	188	
	Custom Designed Arrangement Color: Height: Width:	Contact for Quote		
	Potted Flowers (<i>please circle choice</i>) Kalanchoe Persian Violet Azalea Chrysanthemum Begonia Cyclamen Seasonal	102	121	
	Mums (<i>select color</i>) White Yellow Purple Rust	102	121	
	Small Ferns	64	77	
	Large Ferns	102	121	
	3 – 4 foot green plants	121	146	
	5 – 6 foot green plants	200	241	
	7 – 8 foot green plants	246	295	
		Delivery Charge		21
PLEASE READ PAYMENT POLICY		SUBTOTAL		\$
		Tax (8.5%)		\$
		TOTAL		\$

Plants remain the property of the subcontractor for **CSS**. There will be an **additional charge** for plants **not in the booth** at the conclusion of the event. Floral arrangements are the property of the exhibitor and may be removed from show site. **All flowering plants will be subject to availability.** Substitutes of equal quality may be made upon decision of the florist.

Rental price includes decorative container, top dressing, and professional maintenance. **ALL ORDERS MUST BE PAID IN FULL AT THE TIME THE ORDER IS PLACED.**



1921 Bellamah NW
Albuquerque, NM 87104
t. 505.243.9889
f. 505.243.8197
www.cssabq.com

email us @
esr@cssabq.com

SIGN/GRAPHICS ORDER FORM

CONVENTION SERVICES OF THE SOUTHWEST, INC.

Event Name: SWTA 2023	Advance Payment Deadline: Thursday, February 2, 2023	Booth # (s):
Company Name:	Telephone #:	
Billing Address:	Fax #:	
City/State/Zip:	Email Address:	
Authorized by:		

Fill out section below. Include copy & rough layouts on a separate piece of paper and mail or fax to us. Please circle orientation of signage.

Quantity	Size	Orientation	Letter Color	Advance Price	Standard Price	Total
	7" x 11"	Vertical Horizontal		21	26	
	7" x 44"	Vertical Horizontal		48	58	
	11" x 14"	Vertical Horizontal		60	68	
	14" x 22"	Vertical Horizontal		74	89	
	22" x 28"	Vertical Horizontal		100	120	
	24" x 36"	Vertical Horizontal		135	162	
	28" x 44"	Vertical Horizontal		188	227	
	Meter Board (1 meter x 8')	Vertical (unframed)		425	509	
	Custom Signs	Vertical Horizontal		Contact for Quote		
	Banners			Contact for Quote		

PLEASE READ PAYMENT POLICY.

SUBTOTAL	\$
Tax (8.5%)	\$
TOTAL	\$

Orders placed within 48 hours of show start date will be charged at 150% of the standard price and may be subject to additional delivery or handling charges.

Note: Prices are based on DIGITAL OUTPUT mounted on Foam Core.
If you prefer other materials such as Fabric, Komatex, Plexi Glass, Koraplast, and/or Gator Foam, they will be quoted upon request.

Guidelines for Submitting Artwork:

Artwork should be submitted through the FTP website (please contact us for detailed instructions) or via e-mail in a zip folder (limited to 10 MB per email). In order for us to use a graphic file it must be saved in one of the following file formats:

VECTOR FILES: .AI, .EPS (Please change fonts to outline or include font types.)
RASTER FILES: .PSD, .TIF, .EPS, .JPG

When submitting a raster file, the **optimal resolution is 100 PPI** at 100% or **200 PPI** if file is built at 1/2 size. Lower resolution files will have a negative result on the image quality.

When submitting files, please include the following: Sign/Graphics Order Form, email address/originator of the artwork, printed color copy of the artwork, separations, and CMYK values.

PLEASE ATTACH SIGN COPY AND ANY SPECIAL INSTRUCTIONS:



1921 Bellamah NW
Albuquerque, NM 87104
t. 505.243.9889
f. 505.243.8197
www.cssabq.com

email us @
esr@cssabq.com

FIRE REGULATIONS

CONVENTION SERVICES OF THE SOUTHWEST, INC.

FIRE PREVENTION REGULATIONS

PLEASE READ CAREFULLY AND COMPLETELY!

Aisles are not to be blocked unless it is clearly indicated on the Fire Marshal approved floor plan. Exits, exit signs, and firefighting equipment are not to be blocked or concealed from view in any manner.

Fire inspections may be conducted during the course of move-in and move-out. A pre-opening inspection shall be conducted. Spot inspections may be conducted during the course of the show. The show will not be permitted to open without the approval of the Fire Marshal or his/her authorized representative.

If violations are found during the exhibit, booth(s) shall be subject to closure. Booth operators or employees may also be subject to a citation, which may result in up to a \$500.00 fine, 90 days in jail, or both.

Exhibit booths shall be constructed of non-combustible or limited-combustible materials.

Acoustical and decorative material including, but not limited to cotton, hay, paper, straw, moss, split bamboo, and wood chips shall be flame retardant treated to the satisfaction of the authority having jurisdiction. **Materials that cannot be treated for flame retardancy shall not be used.** Foamed plastics and materials containing foamed plastics used and decorative objects such as, but not limited to mannequins, murals, and signs shall have a maximum heat release rate for any single fuel package of 150 kW when tested in accordance with UL 1975, Standard for Fire Tests for Foamed Plastic used for Decorative Purposes.

FIELD FLAME TEST: Flame retardant materials shall not ignite and spread over the surface when exposed to open flame.

1. Oilcloth, tarpaper, nylon, plastic cloths, and certain other plastic materials cannot be made flame retardant and their use is prohibited.
2. Compressed flammable gases flammable/combustible liquids and hazardous chemicals are prohibited inside the building.
3. The use of LP-Gas cylinders is prohibited. **Exception:** Non-refillable cylinder may be used where permitted by the authority having jurisdiction. Compressed Gas **only** 12-16oz.
4. Hazardous chemicals and materials including pesticides, fungicides, insecticides, caustics, corrosives, oxidizers, flammable, poisons, and toxins are prohibited inside the building.
5. Combustible materials (i.e. crates and boxes) shall be limited to a one (1)-day supply and shall be maintained in an orderly fashion. **Storage of any combustible materials behind booths is prohibited.**

SPECIAL REQUIREMENTS: Vehicles on display within an exposition facility shall comply with the following:

1. All fuel tank openings shall be locked and sealed in an approved manner to prevent the escape of vapors.
2. Battery terminals shall be disconnected and taped off, using a non-metallic tape.
3. Fueling and defueling within the facility is prohibited.
4. Vehicles shall not be moved at any time during show hours.
5. Fuel Limit: Fuel tank shall not exceed one quarter of the tank's capacity or 5 gallons, whichever is less.
6. Vehicles, boats, and similar exhibited products having over 100 sq. ft. (9.3 sq. m.) of roofed area shall be provided with smoke detectors acceptable to the authority having jurisdiction.

OPEN FLAME DEVICES: Neither open flame devices nor pyrotechnic devices shall be used in any assembly occupancy. Cooking and/or warming devices that produce gas laden vapors shall be electric. Sterno may be used for warming trays. Cooking devices shall be approved by a recognized testing laboratory (i.e. UL, FMO).

1. Cooking and/or warming devices shall be isolated from the public, either placing the device a minimum of four (4) feet back from the front of the booth, or providing a barrier between the cooking and/or warming device and the public.
2. Individual cooking and/or warming devices shall not exceed 228" surface area.
3. The label surface holding the cooking and/or warming device(s) shall be of a non-combustible material.
4. A minimum of two (2) feet shall be kept between cooking devices.
5. Combustible materials shall be kept three (3) feet away from any cooking and/or warming device.
6. A 40 BC extinguisher and lid or an approved automatic extinguishing system shall be provided with any booth utilizing

cooking and/or warming devices.

7. Type K fire extinguishers shall be utilized with deep fat fryers or appliances emitting grease laden vapors.
8. Lids to one side, to put on cooking/warming devices.

CANDLES AND OTHER OPEN-FLAME DEVICES: The use of candles and other open-flame devices shall be in accordance with the following:

1. Class I and II liquids and liquefied petroleum gasses shall not be used.
2. Liquid or solid-fueled lighting devices containing more than 8 ounces must self-extinguish and not leak fuel at a rate of more than ¼ teaspoon per minute if tipped over.
3. The devise or holder shall be constructed to prevent the spilling of liquid fuel or wax at the rate of more than ¼ teaspoon per minute when the devise or holder is not in an upright position.
4. The device or holder shall be designed so that it will return to the upright position after being tilted to an angle of 45 degrees from vertical. EXCEPTION: Units that self-extinguish if tipped over and that do not spill fuel or wax at the rate of more than ¼ teaspoon per minute if tipped over.
5. The flame shall be enclosed except as follows: **a)** openings on the sides shall not be more than 3/8 inch in diameter; **b)** openings on the top and the distance to the top shall be such that a single layer of tissue paper placed on the top will not ignite in ten (10) seconds.
6. Chimneys shall be made of noncombustible materials. Such chimneys shall be securely attached to the open-flame device. EXCEPTION: The chimney need not be attached to any open-flame device that will self-extinguish if the device is tipped over.
7. Shades, if used, shall be made of noncombustible materials and securely attached to the open-flame device holder of chimney.
8. Candelabras with flame-lighted candles shall be securely fastened in place to prevent overturning and must be located away from occupants using the area and away from possible contact with drapes, curtains, or other combustibles.
9. When in the opinion of the Fire Marshall, adequate safeguards have been taken, hand-held flame lighted candles can be allowed. Hand-held candles shall not be passed from one person to another while ignited.

FLAMING FOODS AND BEVERAGES: Flaming Foods and Beverages shall be in accordance with the following:

1. Flammable liquids used in the preparation of flaming food and beverage shall be dispensed from a (1) once container or from a container not to exceed a one (1)-quart capacity and having a controlled pouring device that limits the flow to one (1) ounce.
2. Flaming foods or beverages shall be prepared only in the immediate vicinity of the table being served. Flaming food or beverages shall not be transported or carried while burning.
3. The person preparing or serving the flaming foods or beverages shall have a wet cloth towel immediately available for use in smothering the flames in the event of an emergency.
4. The serving of flaming foods or beverages shall be done in a safe manner and shall not create high flames.
5. The pouring, ladling, or spooning of flammable foods or beverages is restricted to a maximum height of eight (8) inches above the receiving receptacle.

IN ALL CASES:

1. All fuel containers shall be secured to prevent spillage when not in use.
2. Fuel canisters shall be safety sealed for storage.
3. Storage or refueling containers are not to exceed a maximum of 16 ounces.
4. The storage of **ANY** combustible behind booths is prohibited.
5. The pouring, ladling, or spooning of flammable liquid is restricted to a maximum height of 8 inches above the receiving receptacle.

No exhibition or show will be permitted to open without the approval of the Fire Marshal or his/her authorized representative. Fire inspections may be conducted during the course of move-in and tear down. A pre-opening inspection shall be conducted. Spot inspections may be conducted during the course of the show. If violations are found during the exhibition or show, violating booth(s) shall be subject to closure.

The Fire Marshal's Office understands that each exhibition, show, or event are different. Depending on the circumstances of the event additional items may need to be addressed. In these instances it will be necessary to follow IFC Section 2416.1 which states in part: When in the opinion of the Fire Marshal, it is essential for public safety in a place of assembly or any other place where people congregate, due to the number of persons, or the nature of the performance, exhibition, display, contest, or activity, the owner, agent, or lessee, shall employ two or more qualified persons from within the fire department. Qualified persons would be as necessary for the greatest life safety, i.e. firefighters, paramedics, full truck crews, etc.



1921 Bellamah NW
Albuquerque, NM 87104
t. 505.243.9889
f. 505.243.8197
www.cssabq.com

email us @
esr@cssabq.com

SAFETY TIPS AND INFORMATION

CONVENTION SERVICES OF THE SOUTHWEST, INC.

Safety is very important for everyone working in the Exhibit Hall.

Convention Services of the Southwest, Inc (**CSS**) values safety throughout our organization and demonstrates it in the work we perform. By following the safety guidelines below, you will be doing your part in creating a safe work environment.

SAFETY GUIDELINES

- Only authorized personnel and employees allowed, all others are prohibited during move-in and move-out.
- Be aware of your surroundings. You are in an active work area with changing conditions. Pay attention.
- All exhibitors and attendees enter at their own risk. Do not enter the dock/yard areas – these areas can be particularly dangerous.
- Stay clear of machinery. Look for obstacles, machinery, and equipment that are in use. Drivers of these vehicles or machines may not be able to see you.
- Never stand on furniture. These objects are not designed to support your standing weight.
- Prevent electrical shocks, falling items, and damage to materials. Do not attach items or equipment to the drapes or metal framework provided for your booth. This can cause serious injury or damage to materials.
- Wear closed toe shoes.
- Clean up or report spills.
- Practice good housekeeping. Keep aisles free and clear of any and all debris.
- Be aware of your surrounding areas for electrical cords or other trip hazards. Sometimes the view of equipment or items may be obstructed.
- Protect valuables at show site.
- Report any fires immediately.

If you notice anything unsafe, please contact a **CSS** employee immediately.

During move-in and move-out unsupervised individuals under the age of 18 are prohibited from being on or around the show floor. Show sites during these times are similar to a construction zone and considered to be hazardous. OSHA regulations prohibit minors from being present in a hazardous work environment.

WORK ZONE

Customer acknowledges that the show site and surrounding areas are active work zones. Customer, its agents, employees and representative are present at their own risk.





Online Exhibitor Ordering

Welcome to the Gaylord Rockies Resort & Convention Center!

We are thrilled to be hosting your 2022 Exposition Event. We're happy to provide access to online ordering for all your booth needs, including:

Electric / AV / Internet / Catering / Hanging Signs

To create an account or log in, please refer to the following link:

<https://gaylordrockies.boomerecommerce.com>

IMPORTANT INFORMATION REGARDING FOOD AND BEVERAGE

Please note that per our contract agreement and for liability reasons, the hotel is the exclusive provider for all food and beverage. Absolutely NO outside food and/or beverages may be served from your booth during this upcoming event (this includes, but is not limited to, logo bottled water or any type of pre-packaged food.) If you wish to serve these items, you must request permission via e-mail in advance, and a corkage fee will apply if your items are approved. These requests can be sent to gh.dengr.grexhibits@gaylordhotels.com.

TAX EXEMPT EXHIBITORS

If your organization is Tax Exempt in the state of Colorado, please create your account first and then contact us at gh.dengr.grexhibits@gaylordhotels.com. We'll need to receive a copy of your Colorado Tax Exempt Certificate before you can process your order.

Please contact an Exhibitor Services Representative at 720.829.8654 or gh.dengr.grexhibits@gaylordhotels.com for any questions or additional assistance.